

# 2022-2023 PRODUCT CATALOG



**RED HEAD<sup>®</sup>**  
*CONCRETE ANCHORING SPECIALISTS*

# *Welcome to the RED HEAD<sup>®</sup> Product and Resource Book*

Our Product and Resource Book is not just a catalog of the quality RED HEAD Anchoring Systems so many of you have come to rely on, but a resource guide to give you the information you need to help you work better, faster and easier.

This highly detailed Application Section allows you to look up your trade or specialty, view a variety of practical applications and receive simple product recommendations. Along with the product recommendations you'll notice page numbers for easy reference to the product selection and specifications pages.

As always, this Product and Resource Book continues to provide a wealth of valuable information including: product approvals/listings, applications, selection charts, performance tables and installation steps.

Remember, if you ever need more information about ITW RED HEAD products, technology and service, contact your local distributor, or look on the back cover for a complete listing of ITW RED HEAD facilities. We welcome your calls and feedback, and look forward to answering any questions you might have.

**[www.itwredhead.com](http://www.itwredhead.com)**

## Fastening Applications Guide

Curtain Wall Applications	3
Electrical Contractor Applications	4
Mechanical Contractor Applications	5
Drywall Contractor and Carpenter Applications	6
Acoustical Ceiling Installer Applications	7
Steel Erector Applications	8
Concrete and Masonry Contractor Applications	9
Water & Waste Water Treatment Applications	10
Highway and Bridge Contractor Applications	11
General Contractor Applications	12
Material Handling Applications	13
Specialty Applications	14

## Anchoring Systems

Anchoring Working Principles	15
------------------------------	----

Anchoring Selection Chart	18
---------------------------	----

Truspec Software	19
------------------	----

## RED HEAD Adhesive Anchoring Systems

Adhesive Anchoring Selection Guide	21
------------------------------------	----

A7+ Adhesive	23
--------------	----

C6+ Adhesive	39
--------------	----

Umbrella Inserts and Short Screens	50
------------------------------------	----

Screen Tubes	53
--------------	----

Accessories	55
-------------	----

## RED HEAD Mechanical Anchoring Systems

Mechanical Anchoring Selection Guide	56
--------------------------------------	----

Trubolt Wedge Anchors	58
-----------------------	----

Large Diameter Tapcon (LDT) Anchors	64
-------------------------------------	----

Multi-Set II Drop-in Anchors	70
------------------------------	----

Dynabolt Sleeve Anchors	75
-------------------------	----

Tapcon Concrete and Masonry Anchors (Original & 410 SS)	78
---	----

Tapcon Maxi-Set	82
-----------------	----

Tapcon SCOTS®	84
---------------	----

Tapcon XL	86
-----------	----

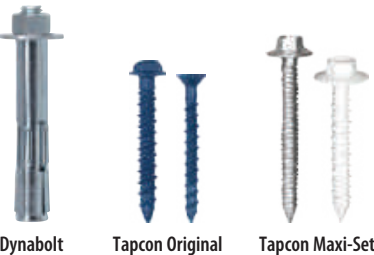

The information and recommendations in this document are based on the best information available to us at the time of preparation. We make no other warranty, expressed or implied, as to its correctness or completeness, or as to the results or reliance of this document.





# RED HEAD®

## Fastening Applications Guide

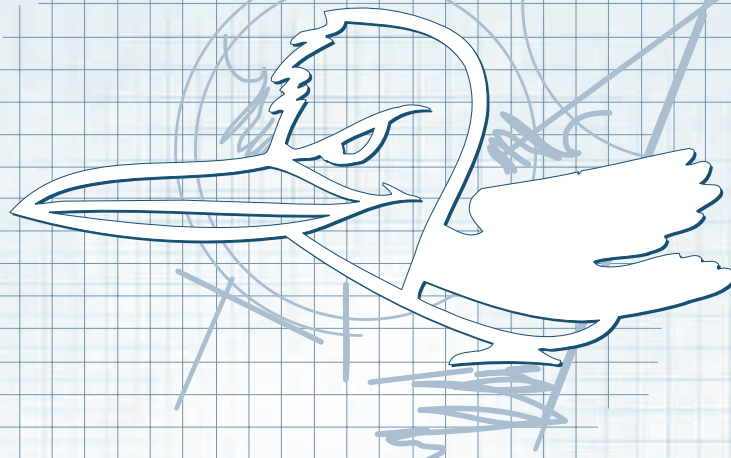

*This section highlights a variety of trade applications and provides information that will assist you in selecting the best fastening system for your application.*

While these are not to be considered complete, they will give you an idea of how contractors use our products.

For example, on the Electrical Contractor page, you will find applications, such as junction box/panel boards and

suspended lighting. Next to the diagrams are the product name(s) and page number in this catalog where you will find complete information on these products needed for that particular application.

### Curtain Wall Applications

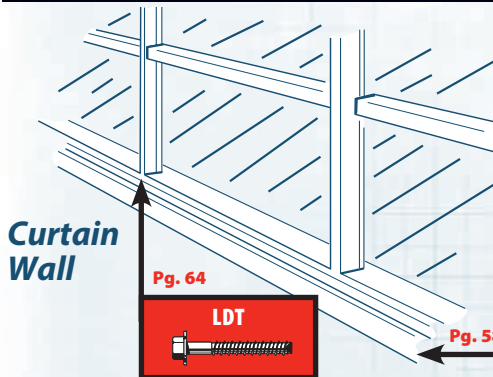

**Curtain Wall**

Pg. 64



- Design allows for expansion and contraction of the frame
- Finished head
- Works in multiple base materials

Pg. 58

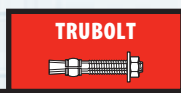

- Can be set thru fixture
- Available in stainless steel
- Can be set with torque wrench

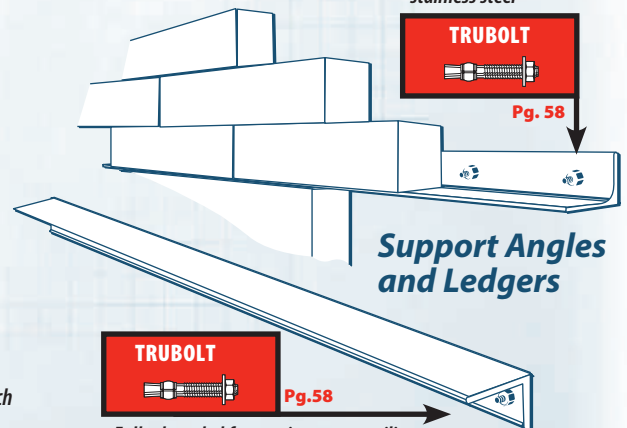

- Fully threaded for maximum versatility
- Available in carbon steel, hot dipped galvanized or stainless steel



Pg. 58

**Support Angles and Ledgers**

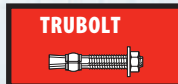

Pg.58

- Fully threaded for maximum versatility
- Carbon steel, hot dipped galvanized or stainless steel available

For seismic recognition, see ICC-ES evaluation reports.

For installation guidelines for your application, please contact our Technical Services Department at 1-800-848-5611.



Call our toll free number 800-848-5611 or visit our web site for the most current product and technical information at [www.itwredhead.com](http://www.itwredhead.com)



# Electrical Contractor Applications

## Junction Box/ Panel Boards

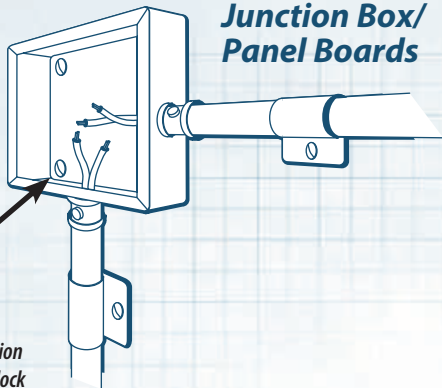

Pg. 78

### TAPCON



- Counter sunk flathead style for flush installation
- Works in concrete or block
- Available in 3/16" and 1/4" diameters

- Available in special 3/8" & 1/2" short version for precast planks
- Available in sizes 1/4" thru 3/4" internal thread diameters

### MULTI-SET DROP-IN



Pg. 70

## Suspended Lighting

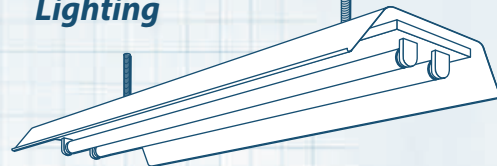

## Transformers Switch Gear Electrical Enclosures

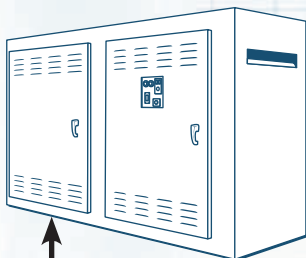

Pg. 58

### TRUBOLT



- Fully threaded for maximum versatility
- Carbon steel, hot dipped galvanized or stainless steel available

- Fully threaded for maximum versatility
- Carbon steel, hot dipped galvanized or stainless steel available

### TRUBOLT



Pg. 58

## Unistrut-Cable Tray/Conduit

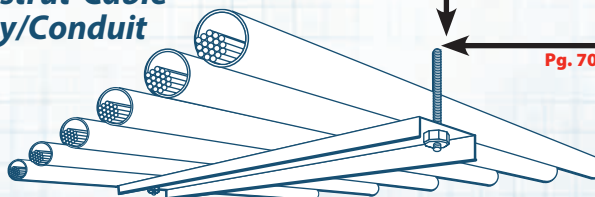

Pg. 70

### MULTI-SET DROP-IN



- Available in special 3/8" & 1/2" short version for precast planks
- Available in sizes 1/4" thru 3/4" internal thread diameters

- Ideal for closely spaced groups of anchors

### A7+ ADHESIVE



Pg. 23

## Light Standards Poles

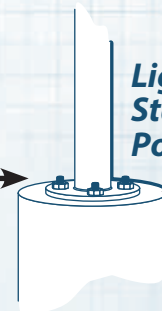

Pg. 39

### C6+ ADHESIVE



- "Stress Free" anchor—can be used close to edges or in close spacing pattern

- Available in special 3/8" & 1/2" short version for precast planks
- Available in sizes 1/4" thru 3/4" internal thread diameters

### MULTI-SET DROP-IN



Pg. 70

## Suspended Pipe or Conduit

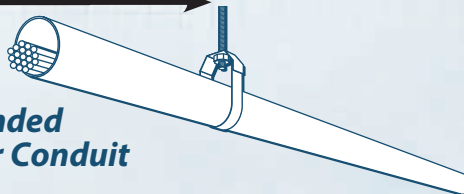

## Wall Mounted Lighting



Pg. 75

### DYNABOLT



- Counter sunk and threshold head styles also available
- Works in concrete, block and brick

Pg. 64

### LDT



- Works in solid concrete, hollow block and brick
- Cuts a thread into the mounted surface
- Finished head appearance

For seismic recognition, see ICC-ES evaluation reports.

For installation guidelines for your application, please contact our Technical Services Department at 1-800-848-5611.

# Mechanical Contractor Applications

**NOTE:**  
C6+ can be used for oversized holes when repairing pumps and machinery anchoring.

## Machinery and Equipment

**Pg. 64**  
**LDT**  
• Removable



**Pg. 39**  
**C6+ ADHESIVE**



**Pg. 23**  
**A7+ ADHESIVE**  
• Vibration resistant  
• Quick-Cure



- Fully threaded for maximum versatility
- Carbon steel, hot dipped galvanized or stainless steel available

- Simple to install—drill hole and screw in
- Fire resistant

## Pumps

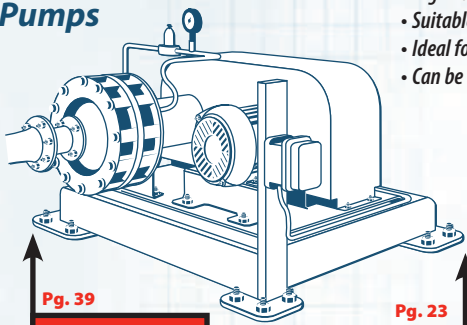

**Pg. 39**  
**C6+ ADHESIVE**



- Corrosion resistant
- Vibration resistant
- NSF Approved

**Pg. 23**  
**A7+ ADHESIVE**



- Quick-Cure
- Vibration Resistant

**TRUBOLT**  
**Pg. 58**



**TAPCON**  
**Pg. 78**



## Ductwork/HVAC

## Heavy-Duty Pipe Support

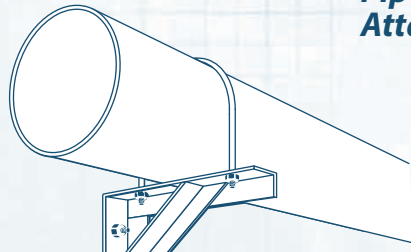

**Pg. 39**  
**C6+ ADHESIVE**



- High load capacity
- Corrosion resistant
- NSF Approved

**Pg. 58**  
**TRUBOLT**



- Fully threaded for maximum versatility
- Carbon steel, hot dipped galvanized or stainless steel available

## Pipe/Strut Attachment

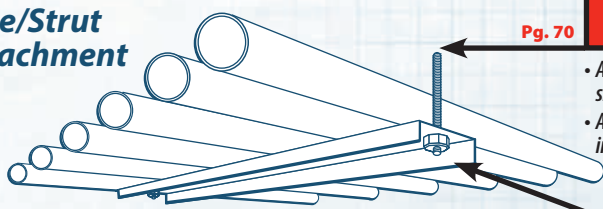

**Pg. 70**  
**MULTI-SET DROP-IN**



- Available in special 3/8" & 1/2" short version for precast planks
- Available in sizes 1/4" thru 3/4" internal thread diameters

**Pg. 58**  
**TRUBOLT**



- Available in special 3/8" & 1/2" short version for precast planks
- Available in sizes 1/4" thru 3/4" internal thread diameters

- Fully threaded for maximum versatility
- Carbon steel, hot dipped galvanized or stainless steel available

**Pg. 70**  
**MULTI-SET DROP-IN**



## Pipe Support, Fire Sprinkler



For seismic recognition, see ICC-ES evaluation reports.

For installation guidelines for your application, please contact our Technical Services Department at 1-800-848-5611.



Call our toll free number 800-848-5611 or visit our web site for the most current product and technical information at [www.itwredhead.com](http://www.itwredhead.com)



# Drywall Contractor & Carpenter Applications

## Window and Door Frames

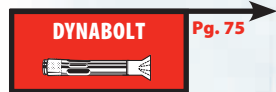

- Counter sunk and threshold head styles
- Works in concrete, block and brick



- Works in solid and hollow base material
- Removable
- Can be set flush with Phillips head if counter sunk

## Drywall Track

### Ceiling Track

### Floor Track



- Simple to use—drill hole and screw in

Pg. 78



- Counter sunk flathead style for flush installation
- Works in concrete or block
- Available in 3/16" and 1/4" diameters

## Furring Strips

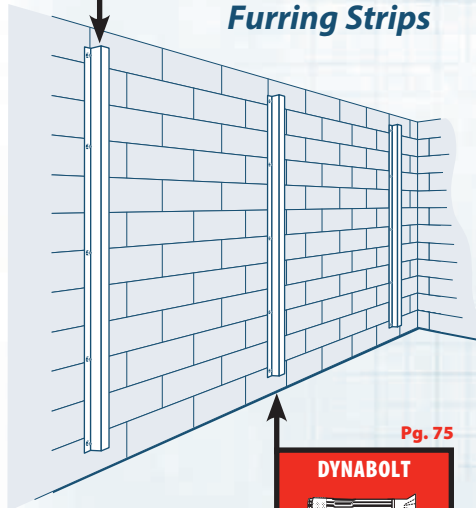

- Counter sunk and threshold head styles
- Works in concrete, block and brick

## Framing/Sill Plating

- Drill hole, install by hand or impact wrench

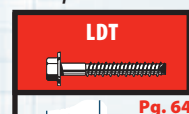

Pg. 58

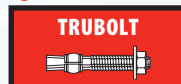

- Fully threaded for maximum versatility
- Carbon steel, hot dipped galvanized or stainless steel available

Pg. 39



- High load capacity
- Corrosion resistant
- NSF Approved
- Used for slower cure projects

Pg. 23



- Fast cure
- Works in damp wet conditions
- Use A7+ with threaded rod for this application

For seismic recognition, see ICC-ES evaluation reports.

For installation guidelines for your application, please contact our Technical Services Department at 1-800-848-5611.



# Acoustical Ceiling Installer

## Applications

- Single piece design
- Drill hole, hammer wedge into hole, pull down with claw hammer

**TIE WIRE WEDGE**

Pg. 58

- Tapcon used with angle clip
- Simple to use, drill hole and drive Tapcon

**TAPCON**

Pg. 78

**Acoustical Ceiling**

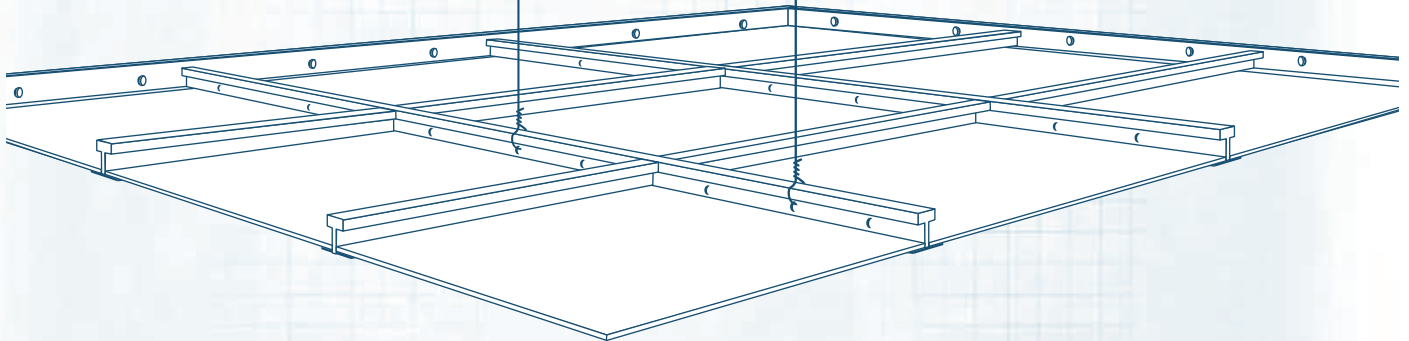

For seismic recognition, see ICC-ES evaluation reports.

For installation guidelines for your application, please contact our Technical Services Department at 1-800-848-5611.



Call our toll free number 800-848-5611 or visit our web site for the most current product and technical information at [www.itwredhead.com](http://www.itwredhead.com)





# Steel Erector Applications

## Steel Beams/Columns

Pg. 39

### C6+ ADHESIVE

- Longer working time for positioning of steel
- Can be used in oversized holes
- Works in wet/damp conditions

Pg. 23

### A7+ ADHESIVE

- Ideal for closely spaced groups of anchors

Pg. 58

### TRUBOLT

- Fully threaded for maximum versatility
- Carbon steel, hot dipped galvanized or stainless steel available

## Stairs and Ladders

- Fully threaded for maximum versatility
- Carbon steel, hot dipped galvanized or stainless steel available

### TRUBOLT

Pg. 58

Pg. 23

### A7+ ADHESIVE

- Fast cure
- Works in damp wet conditions
- Use A7+ with threaded rod for this application

Pg. 64

### LDT

- Finished head
- Removable
- For use in concrete

## Ornamental Iron

### DYNABOLT

Pg. 75

- Multiple head styles
- Ideal for concrete, brick and block
- Carbon and stainless steel

Pg. 23

### A7+ ADHESIVE

- Fast cure
- Works in damp wet conditions
- Use A7 with threaded rod for this application

- Fully threaded for maximum versatility
- Carbon steel, hot dipped galvanized or stainless steel available

## Hand Railings

### TRUBOLT

Pg. 58

- Quick cure
- Works in damp wet conditions
- Works in concrete & masonry

Pg. 23

### A7+ ADHESIVE

### DYNABOLT

Pg. 75

- Multiple head styles
- Ideal for concrete, brick and block
- Carbon and stainless steel

## Protective Railings and Fencing

- Fully threaded for maximum versatility
- Carbon steel, hot dipped galvanized or stainless steel available

### TRUBOLT

Pg. 58

Pg. 64

### LDT

- Finished head
- Removable
- For use in concrete

For seismic recognition, see ICC-ES evaluation reports.

For installation guidelines for your application, please contact our Technical Services Department at 1-800-848-5611.

# Concrete & Masonry Contractor Applications

## Concrete Block Reinforcement

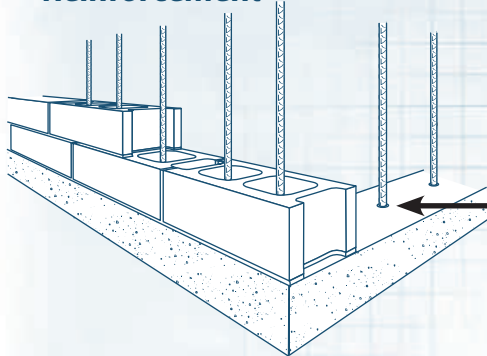

- NSF/ANSI 61
- Vibration resistant
- Corrosion resistant

Pg. 39 **C6+ ADHESIVE**

Pg. 23 **A7+ ADHESIVE**

- Fast curing adhesive—ideal for moderate to cold climates

## Rebar Doweling

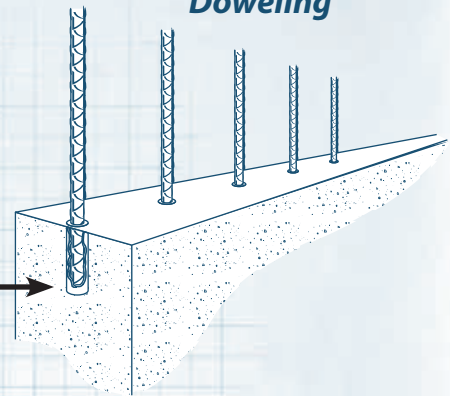

## Stone Attachment

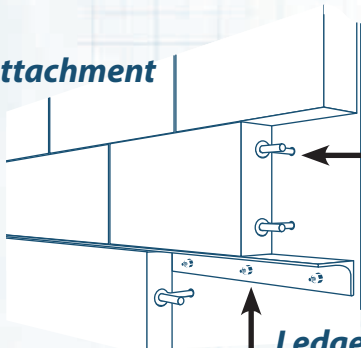

Pg. 58

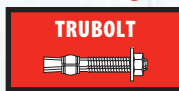

- Fully threaded for maximum versatility
- Carbon steel, hot dipped galvanized or stainless steel available

## Ledger Angle Attachment

## Brick Pinning

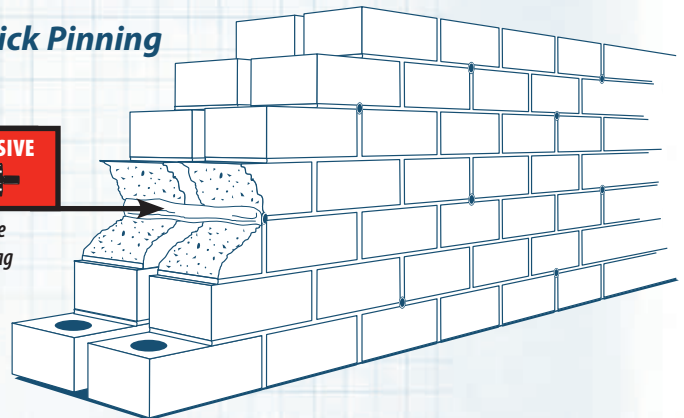

Pg. 23 **A7+ ADHESIVE**

- Compact space
- No-drip—no sag formula
- Easy clean up

## Stone Attachment

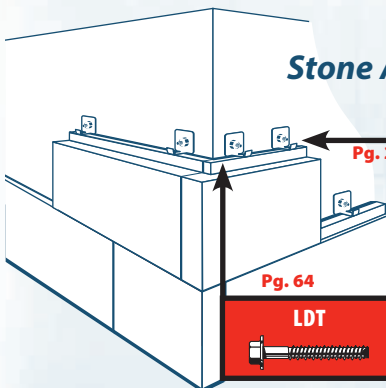

Pg. 64



- Finished head
- Removable
- For use in concrete

Pg. 23 **A7+ ADHESIVE**

- High load capacity in concrete block
- No drip—no sag formula
- Easy clean up

## Concrete Formwork

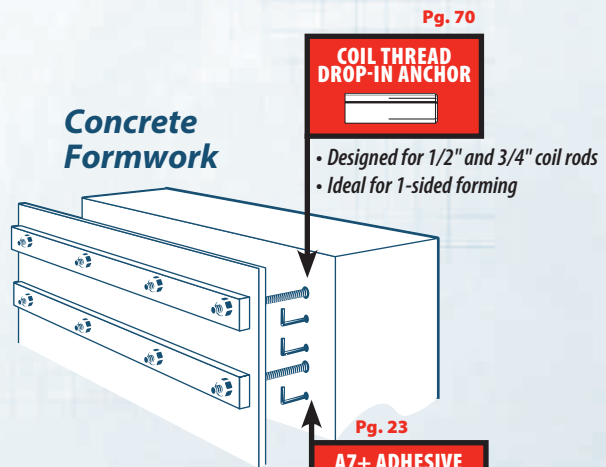

Pg. 70



- Designed for 1/2" and 3/4" coil rods
- Ideal for 1-sided forming

Pg. 23



- Fast curing adhesive for rebar doweling

For seismic recognition, see ICC-ES evaluation reports.

For installation guidelines for your application, please contact our Technical Services Department at 1-800-848-5611.



Call our toll free number 800-848-5611 or visit our web site for the most current product and technical information at [www.itwredhead.com](http://www.itwredhead.com)



# Water & Waste Water Treatment Applications

## Weirs and Gates

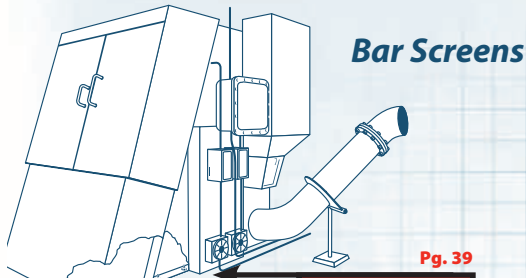

**Bar Screens**

Pg. 39



- NSF/ANSI 61
- Vibration resistant
- Corrosion resistant

**Covers and Domes**

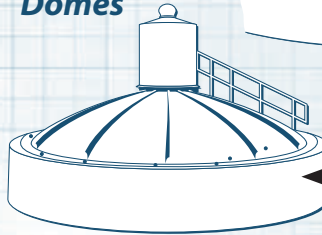

Pg. 39



- NSF/ANSI 61
- Vibration resistant
- Corrosion resistant

Pg. 23



- NSF/ANSI 61
- Fast dispensing, fast curing adhesive
- Works with epoxy coated dowels



- Fast dispensing, fast curing adhesive
- Works in wet conditions
- NSF Approved

**Railings and Ladders**



Pg. 23/39

- NSF/ANSI 61
- Vibration resistant
- Install close to edge



Pg. 58

- Fully threaded for maximum versatility
- Carbon steel, hot dipped galvanized or stainless steel available

**Instrumentation and Controls**

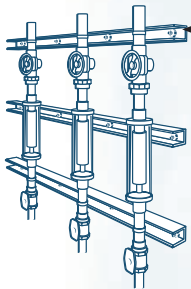

Pg. 58



- Fully threaded for maximum versatility
- Carbon steel, hot dipped galvanized or stainless steel available

**Pipe Supports**

- Special 3/8" short version for prestressed concrete
- Available in 1/4" thru 3/4" internal diameters
- Stainless steel available

- Fully threaded for maximum versatility
- Carbon steel, hot dipped galvanized or stainless steel available



Pg. 58

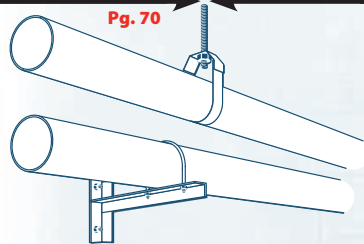
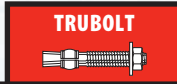

Pg. 70

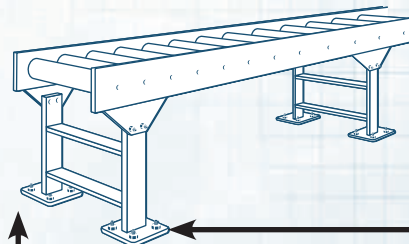

**Conveyors**

Pg. 58



- Fully threaded for maximum versatility
- Carbon steel, hot dipped galvanized or stainless steel available

Pg. 64



- Finished head
- Removable
- Install by hand or with impact wrench

**Diffusers**

Pg. 23



- Fast dispensing, fast curing adhesive
- Works with epoxy coated dowels
- NSF Approved

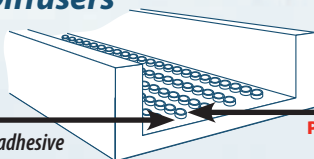

Pg. 39



- NSF/ANSI 61
- Vibration resistant
- Corrosion resistant
- Can be installed underwater

**PUMPS**



- NSF/ANSI 61
- Vibration resistant
- Corrosion resistant
- Can be used in oversize holes

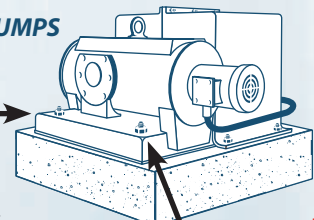

Pg. 58

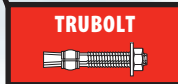

- Fully threaded for maximum versatility
- Carbon steel, hot dipped galvanized or stainless steel available

For seismic recognition, see ICC-ES evaluation reports.

For installation guidelines for your application, please contact our Technical Services Department at 1-800-848-5611.



# Highway & Bridge Contractor Applications

## Concrete Pavement Lane Addition and Joint Repair

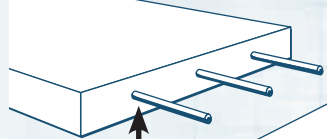

Pg. 23/39



- Works with epoxy coated dowels

Pg. 70



- Lipped anchor—remains flush with face of concrete

### "J" Bolt

- With or without lip

- Can be used overhead

A7+/C6+ ADHESIVE

Pg. 23/39

## Bridge Mounted Signs

## Down Spouts

Pg. 58

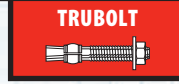

- Fully threaded for maximum versatility
- Carbon steel, hot dipped galvanized or stainless steel available

## Suspended Conduit

Pg. 23



- Fast curing
- Can be used in damp or water filled holes

## Wire Loops

## Glare Screens

Pg. 58

Pg. 64

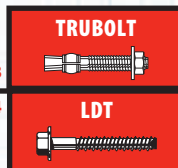

- Fully threaded for maximum versatility
- Carbon steel, hot dipped galvanized or stainless steel available

- Finished head
- Removable
- Install by hand or with impact wrench

- Can be used in wet/damp conditions
- Fast cure
- Easy to pump



Pg. 23

## Guard Rail Attachments to Bridges

## Rebar Doweling

Pg. 23/39



- Can be used in damp or water filled holes

## Temporary Fastening of Jersey Barriers to Concrete

Pg. 58



- Fully threaded for maximum versatility
- Carbon steel, hot dipped galvanized or stainless steel available



Pg. 23

- Can be used in wet/damp conditions
- Fast cure
- Easy to pump
- Suitable for use close to edge of slab

## Steel Guard Rail Post Attachment to Concrete

Pg. 39



- High Load Capacity
- Suitable for use close to edge of slab
- Ideal for moderate to hot climates
- Can be used for oversized holes

For seismic recognition, see ICC-ES evaluation reports.

For installation guidelines for your application, please contact our Technical Services Department at 1-800-848-5611.

## Department of Transportation Approvals & Listings

For approvals contact local engineering on a per project basis.

Call your local RED HEAD sales person for more information.



Call our toll free number 800-848-5611 or visit our web site for the most current product and technical information at [www.itwredhead.com](http://www.itwredhead.com)



# General Contractor Applications

## Replacement of Misplaced Anchors

**Pg. 39**  
**C6+ ADHESIVE**

- Ideal for hot climates—extended working time formula

**Pg. 64**  
**LDT**

**Pg. 23**  
**A7+ ADHESIVE**

**Cast-In-Place Bolt in Wrong Location**

- Damp holes or underwater
- Dispenses and cures faster in cold weather

## Tilt Wall Anchorage

**Pg. 58**  
**TRUBOLT**

- Fully threaded for maximum versatility
- Carbon steel, hot dipped galvanized or stainless steel available

## Seismic Hold Downs

**Pg. 23**  
**A7+ ADHESIVE**

- Damp holes or underwater
- Fastest cure (35 min. at 60°F)
- Dispenses and cures faster in cold weather

**Pg. 23/39**  
**A7+/C6+ ADHESIVE**

- High Load Capacity
- Suitable for use close to edge of slab
- Ideal for moderate to hot climates
- C6+ can be used for oversized holes

**Pg. 23**  
**A7+ ADHESIVE**

- Damp holes or underwater
- Fastest cure (35 min. at 60°F)
- Dispenses and cures faster in cold weather

**Pg. 39**  
**C6+ ADHESIVE**

**Damaged Cast-In-Place Anchor**

**Pg. 39**  
**C6+ ADHESIVE**

**Replacement of Damaged Anchors**

- NSF Approved
- Vibration resistant
- Corrosion resistant
- Can be used in oversize holes

- Extended working time—ideal for warm to hot climates
- Can be used in oversize holes

For seismic recognition, see ICC-ES evaluation reports.

For installation guidelines for your application, please contact our Technical Services Department at 1-800-848-5611.

# Material Handling Applications

**Overhead Doors**

**Pg. 64** **LDT**

- Hand installation block or concrete

**Pg. 23/50** **A7+ ADHESIVE WITH UMBRELLA**

- High load in hollow block or concrete

**Shelving**

- Removable
- Easy to install
- Single piece design

**Pg. 64** **LDT**

**Pg. 58** **TRUBOLT**

- Fully threaded for maximum versatility
- Available in carbon steel, hot dipped galvanized or stainless steel

**Conveyors**

**Pg. 64** **LDT**

- Finished head
- Removable
- Installs with impact wrench
- Single piece design

**Pg. 58** **TRUBOLT**

- Fully threaded for maximum versatility
- Available in carbon steel, hot dipped galvanized or stainless steel

**Rails**

**Pg. 64** **LDT**

- Finished head
- Removable
- Installs with impact wrench

**Pg. 23** **A7+ ADHESIVE**

- Fast curing
- Impact resistant
- Non-sag formula

**Pg. 23** **A7+ ADHESIVE**

- Fast curing
- Impact resistant
- Non-sag formula

**Pg. 39** **C6+ ADHESIVE**

- Extended working time—ideal for warm to hot climates
- Can be used in oversize holes

**Dock Bumpers**

**Pg. 64** **LDT**

- Finished head
- Removable
- Available with Envirex corrosion resistant high finish

**Racks**

**Pg. 58** **TRUBOLT**

- Fully threaded for maximum versatility
- Available in carbon steel, hot dipped galvanized or stainless steel

**Pg. 64** **LDT**

- Finished head
- Removable
- Installs with impact wrench
- Single piece design

For seismic recognition, see ICC-ES evaluation reports.

For installation guidelines for your application, please contact our Technical Services Department at 1-800-848-5611.



# Specialty Applications

## Stadium Seating

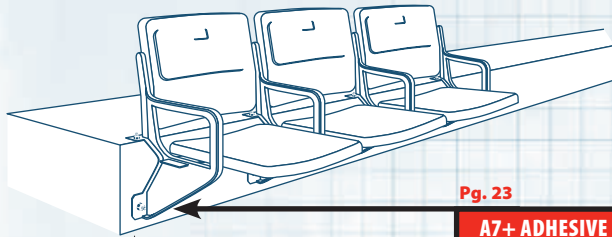

Pg. 58

### TRUBOLT



- Fully threaded for maximum versatility
- Available in carbon steel, hot dipped galvanized or stainless steel

Pg. 23

### A7+ ADHESIVE



- Corrosion resistant
- Normal weight or lightweight concrete
- Used in major stadiums across the country

## Foundation Wrap

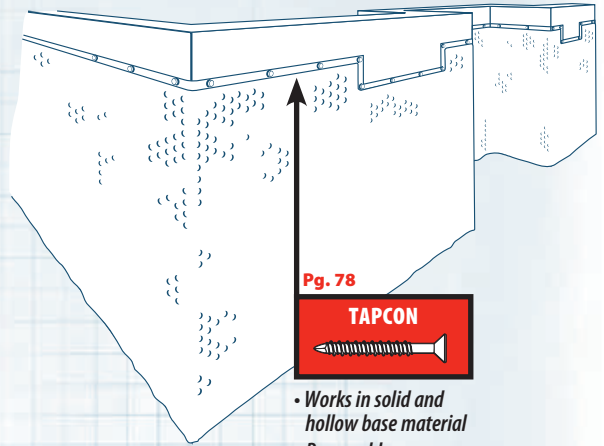

Pg. 78

### TAPCON



- Works in solid and hollow base material
- Removable

## Expansion Joints



- Fully threaded for maximum versatility
- Available in carbon steel, hot dipped galvanized or stainless steel

Pg. 58

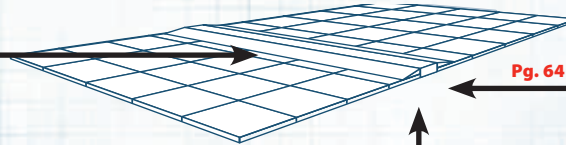

Pg. 39

### C6+ ADHESIVE

- High load capacity
- Suitable for use close to edge of slab



Pg. 64

- Finished head
- Removable
- Installs by hand or with impact wrench

## Flooring Systems

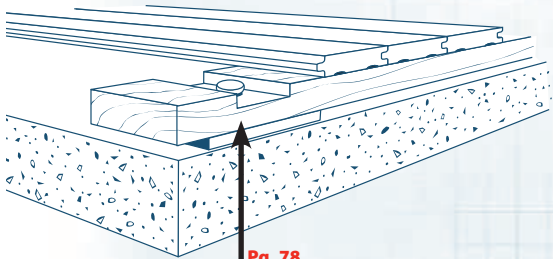

Pg. 78

### TAPCON

- Works in solid and hollow base material
- Removable
- Can be set flush with Phillips head if countersunk

## Underwater Installation

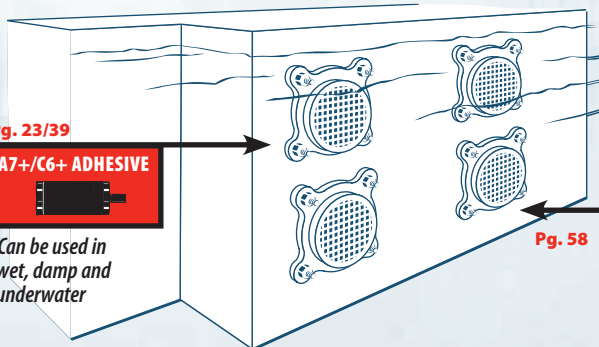

Pg. 23/39

### A7+/C6+ ADHESIVE

- Can be used in wet, damp and underwater

Pg. 58

### TRUBOLT



- Fully threaded for maximum versatility
- Available in carbon steel, hot dipped galvanized or stainless steel

For seismic recognition, see ICC-ES evaluation reports.

For installation guidelines for your application, please contact our Technical Services Department at 1-800-848-5611.



## The Inside Story About Mechanical and Adhesive Anchors

Types, Base Materials,  
Installation Procedures  
and More

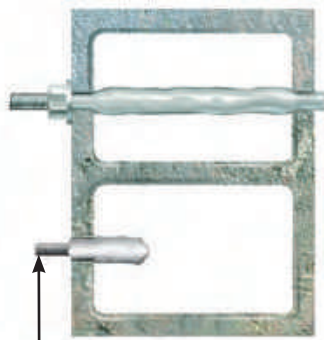

Top View

For attachments to single face of block, see page 60 for information on "umbrella anchors" and "short screens"

### HOLLOW CONCRETE BLOCK

Maximum holding strength in concrete block can be obtained by fastening to both the front and back of the block using an adhesive screen tube and threaded rod.

## TYPES OF ANCHORS

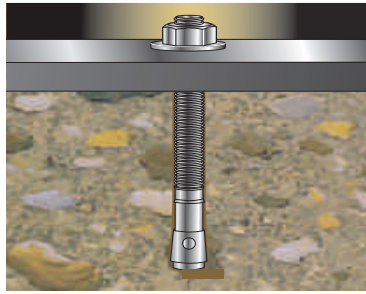

### Expansion Type—

Tension loads are transferred to the base material through a portion of the anchor that is expanded inside the drill hole.

**Examples:** Red Head Trubolt, Dynabolt Sleeve Anchor and Multi-Set II Drop-In Anchor



### Adhesive Type—

Resistance to tension loads is provided by the presence of an adhesive between the threaded rod (or rebar) and the inside walls of the drill hole.

**Examples:** A7+ and C6+ Adhesives

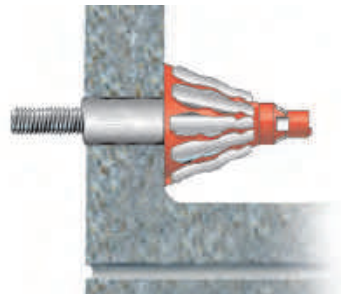

### Keying Type—

Holding strength comes from a portion of an anchor that is expanded into a hollow space in a base material that contains voids such as concrete block or brick.

**Examples:** Adhesive Umbrella Anchors

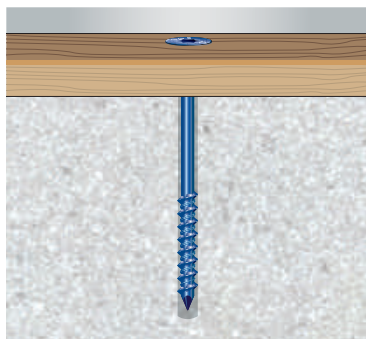

### Screw Type—

Tension loads are resisted by threads on the fastener engaging with grooves cut into the base material.

**Examples:** LDT, Tapcon and E-Z Ancors

# Anchoring Working Principles cont.

## BASE MATERIALS

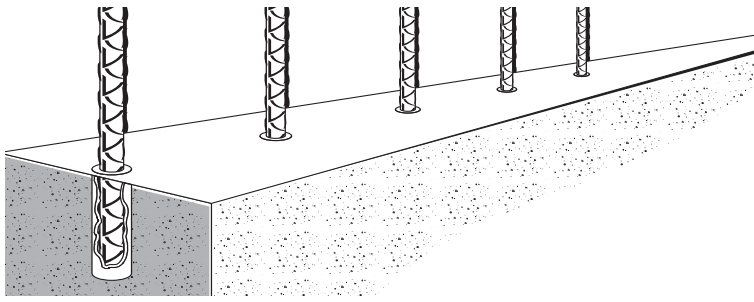

### Concrete

**Normal Weight Concrete** is made from Portland cement, coarse and fine aggregates, water and various admixtures. The proportioning of these components controls the strength of the concrete. In the United States, concrete strength is specified by the compressive strength\* of concrete test cylinders. These test cylinders measure six inches in diameter by 12 inches in length and are tested on the 28th day after they are produced.

**Lightweight Concrete** consists of the same components (cement, coarse and fine aggregates, water and admixtures) as normal weight concrete, except it is made with lightweight aggregate. One of the most common uses of lightweight concrete has been as a structural fill of steel decking in the construction of strong, yet light floor systems.

Typical fasteners for both normal weight and lightweight concrete include Trubolt Wedge Anchors, LDT Self-Threading Anchors, Dynabolt Sleeve Anchors, Multi-Set II Drop-In Anchors and Adhesive Anchoring Systems.

\* Compressive strengths shown in this catalog were the actual strengths at the time of testing. The load values listed were determined by testing in un-reinforced concrete.

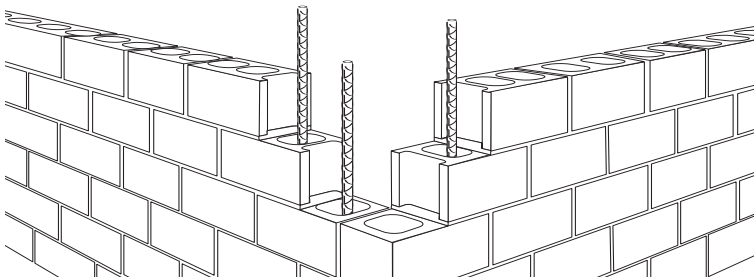

### Masonry

**Grout-Filled Concrete Block** consists of three components: concrete, mortar and grout. The mortar is designed to join the units into an integral structure with predictable performance properties. Typical fasteners for grout-filled block include Dynabolt Sleeve Anchors, A7+ and C6+ Adhesive Anchoring Systems.

**Hollow Concrete Block, Brick and Clay Tile** are grouped together because they require special anchoring products that can be installed into a substrate that contains voids and still provide reliable holding values. Typical fasteners used in hollow block, brick and clay tile include Dynabolt Sleeve Anchors, Tapcon Self-Tapping Concrete Anchors, Adhesives with Screen Tubes and Adhesives used with the Umbrella Anchor.

## INSTALLATION PROCEDURES

Anchor drill holes are typically produced using carbide tipped drill bits and rotary hammer drills. Look at the product sections of this catalog for the correct drill hole diameter and depth of each type of anchoring system.

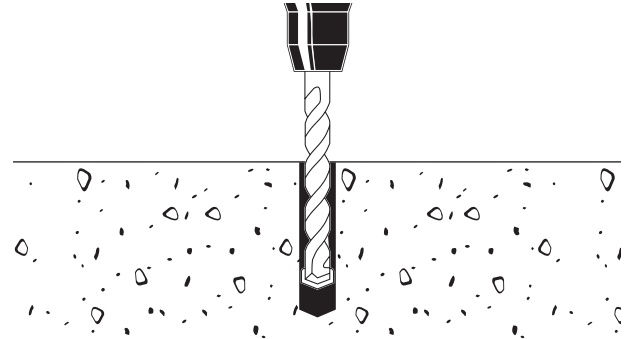

Careful cleaning of the anchor drill hole is important in order to obtain the best possible functioning of the anchor system. For each product in this catalog, detailed installation instructions are provided. Suggested clamping force and curing times (for adhesive anchors) are also provided.

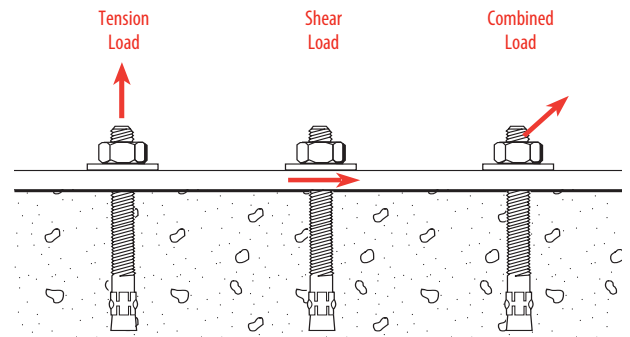

### Loading

Holding values for the following types of loading are provided in this catalog:

- **Tension loads—**  
when load is applied along the axis of the anchor
- **Shear loads—**  
when the loads are applied perpendicular to the axis of the anchor
- **Combined loads—**  
when both tension and shear loads are applied to an anchor, a combined loading equation is provided to determine the maximum loads that can be applied to the anchor at the same time



## MODES OF FAILURE

When anchors are loaded to their maximum capacity, several different types (modes) of failure are possible depending on the type of anchor, strength of the base material, embedment depth, location of the anchor, etc. Common modes of failure include:

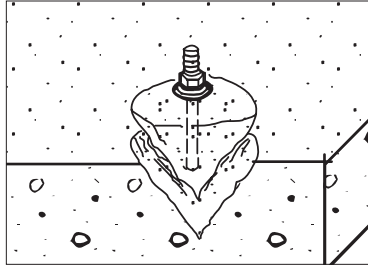

### **Concrete Spall Cone—**

Occurs at shallow embedments where the resistance of the base material is less than the resistance of the anchor and the base material fails.

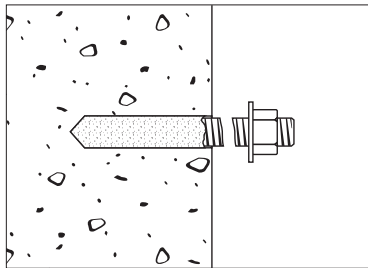

### **Steel Breakage—**

The capacity of the anchorage exceeds the tensile or shear strength of the steel anchor or rod material.

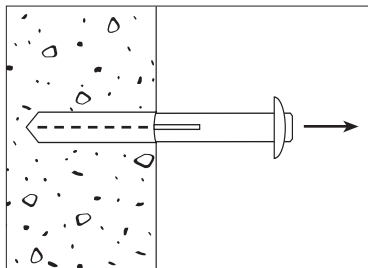

### **Anchor Pullout—**

Base material adjacent to the extension portion of an anchor crushes, resulting in the anchor pulling out of the hole until the capacity of the spall cone is reached, at which point the concrete will spall. This type of failure happens more commonly when anchors are set with deep embedment depths.

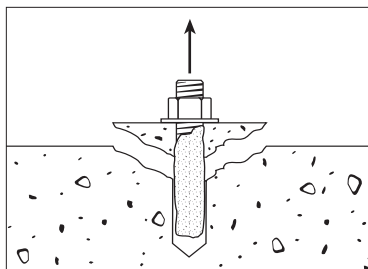

### **Bond Failure—**

Shear failure of the adhesive at rod-adhesive interface or adhesive-base material interface. Occurs more commonly in deep embedments using high strength steel rods.

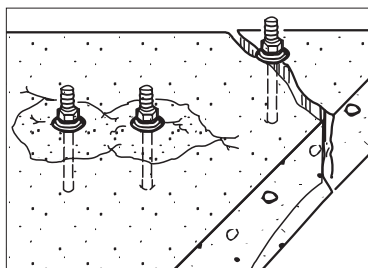

### **Edge Distance and Spacing Reduction—**

Reduces the holding values, when anchors are placed too close to the edge. This also occurs when two or more anchors are spaced closely together. See suggested edge distance, anchor spacing distances and reduction values in the product sections.

Because applications vary, ITW RED HEAD cannot guarantee the performance of this product. Each customer assumes all responsibility and risk for the use of this product. The safe handling and the suitability of this product for use is the sole responsibility of the customer. Specific job site conditions should be considered when selecting the proper product. Should you have any questions, please call the Technical Assistance Department at 800-848-5611.

# Anchoring Selection Chart

Anchor Selection Chart		Adhesive Anchors		Screw Anchors		Expansion Anchors	
		A7+	C6+	LDT	Tapcon	Torque-Set	
						Trubolt	Dynabolt
Base Material	Uncracked Concrete	A7+	C6+	LDT	TAP	TRU	DYNA
	Cracked Concrete	A7+	C6+				
	Lightweight Concrete	A7+	C6+		TAP	TRU	DYNA
	Lightweight Concrete on Metal Deck			LDT		TRU	
	Hollow Core Concrete						
	Grout Filled Concrete Block	A7+	C6+	LDT			DYNA
	Hollow Concrete Block	A7+	C6+	LDT	TAP		DYNA
	Solid Brick	A7+	C6+				
	Drywall						
Hole Conditions	Oversized Holes		C6+				
	Water Saturated Concrete	A7+	C6+	LDT		TRU	DYNA
	Water-filled Holes	A7+	C6+	LDT		TRU	DYNA
	Submerged	A7+	C6+				
	No Hole Cleaning Procedures						
Application Requirements	Through Fixture Fastening	A7+	C6+	LDT	TAP	TRU	DYNA
	Immediate Loading			LDT	TAP	TRU	DYNA
	Finished Head or Flush Surface			LDT	TAP		DYNA
	Easy to Remove			LDT	TAP		
	Seismic	A7+	C6+				
	Cyclic Loading	A7+	C6+			TRU	
	High Temperature Resistance	A7+	C6+	LDT	TAP	TRU	DYNA
	Sustained Load	A7+	C6+	LDT	TAP	TRU	DYNA
Corrosion Resistance	Zinc Plated	A7+	C6+			TRU	DYNA
	Hot-Dipped Galvanized	A7+	C6+			TRU	
	304 Stainless Steel	A7+	C6+			TRU	DYNA
	316 Stainless Steel	A7+	C6+			TRU	
	410 Stainless Steel	A7+	C6+	LDT	TAP		
	Trade Secret Coating			LDT	TAP		
Anchor Diameters	3/16"				TAP		
	1/4"	A7+			TAP	TRU	DYNA
	5/16"				TAP		DYNA
	3/8"	A7+	C6+	LDT		TRU	DYNA
	1/2"	A7+	C6+	LDT		TRU	DYNA
	5/8"	A7+	C6+	LDT		TRU	DYNA
	3/4"	A7+	C6+	LDT		TRU	DYNA
	7/8"	A7+	C6+				
	1"	A7+	C6+				
	1-1/4"	A7+	C6+				
	Rebar Sizes	#3-11	#3-11				
At 70°F	Working Time (minutes)	5	16				
	Cure Time (minutes)	45	390				

➤ **FREE SOFTWARE!**

# truspec

ANCHOR CALCULATION SOFTWARE 3.0



The most user-friendly anchor design software is now even better, allowing you to do more types of anchor designs from anywhere, be that in the office or out on the jobsite.

## NEW! Access cloud-based Truspec 3.0 via web browser from your computer or mobile device

- Cloud-based version means users always have access to the latest features, without the hassle of installing updates.
- Can access from 4G mobile devices even without wifi internet connection

## Versatile – do everything in one package

- **NEW** Supports cast-in as well as post-installed anchor design
- **NEW** Supports anchoring to masonry as well as concrete substrates
- **NEW** Allows you to customize base plate shapes and anchor layouts

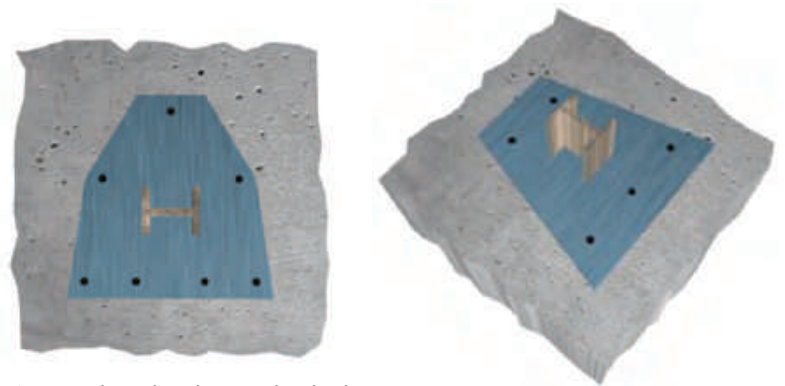

Customize base plate shapes and anchor layouts

## Accurate, reliable, code-compliant anchor designs

- **NEW** Supports ACI318 Strength Design method for concrete, including cracked and seismic conditions.
- Also supports anchor design in accordance with Canada CSA standards.
- **NEW** Truspec 3.0 lets you enter multiple load combinations and calculates the worst-case controlling combination for you
- **NEW** Truspec 3.0 checks your base plate design using finite element analysis to ensure adequate rigidity



Quickly enter multiple load combinations and determine the controlling combo



Call our toll free number 800-848-5611 or visit our web site for the most current product and technical information at [www.itwredhead.com](http://www.itwredhead.com)





## Intuitive, easy to use

- Consistently ranked by designers as one of the simplest anchor design programs to learn and use, Truspec 3.0 walks you through the anchor design and selection process in six easy steps – saving time and preventing errors
- Customizable templates are provided for common anchoring applications like base plates, end plates and safety railings
- Graphical user interface provides 2D and 3D design views making it easy to visualize all design elements at a glance
- Tooltip messages provide helpful information whenever the cursor is positioned over an element on the user interface
- Animated indicators simplify and speed the input of tensile, shear and moment load values
- Truspec allows you to filter anchor recommendations by type, diameter, steel grade, etc. Truspec also ranks the viable options to show which are the most efficient from a capacity utilization perspective

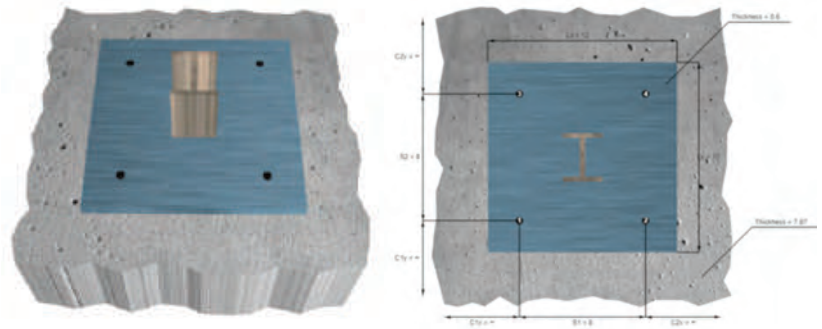

View anchor designs in 2D or 3D perspective

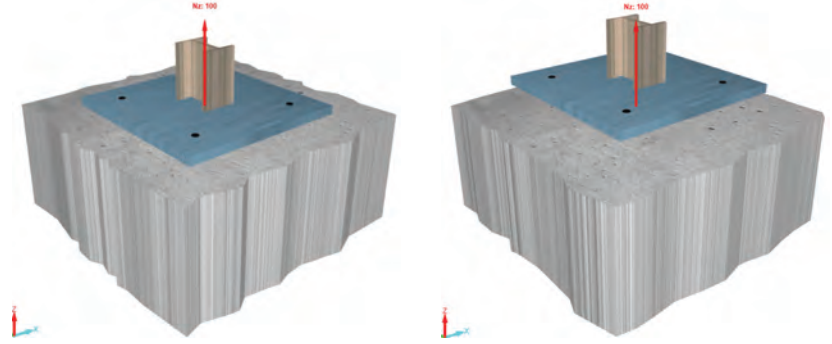

Animated display graphically shows load direction

The **NEW**, enhanced design report shows all inputs, formulas, and calculations with relevant standards citations, plus complete anchor product info and installation instructions

➤ **Truspec 3.0 is a FREE web-based program that provides sophisticated anchor design support to structural and nonstructural engineers.**

**visit:**  
**[www.itwredhead.com/truspec](http://www.itwredhead.com/truspec)**

## USE TRUSPEC 3.0 SOFTWARE WITH THE FOLLOWING POPULAR ANCHORING PRODUCTS: CHEMICAL ANCHORING ADHESIVES

### ➤ Red Head A7+ Adhesive

- The most versatile quick cure
- Fast-curing, all-weather hybrid adhesive

### ➤ Red Head C6+ Adhesive

- For the most demanding applications
- Maximum strength epoxy adhesive

## POST-INSTALLED MECHANICAL ANCHORS

### ➤ Trubolt Wedge Anchors

- Dependable, heavy-duty expansion anchor

### ➤ Tapcon and Tapcon+ Screw Anchors

- Fast installation with reliable holding power

### ➤ Sammys Threaded Rod Hangers

- Accommodates vertical, horizontal and angled attachments

## CAST-IN ANCHORS

### ➤ Hex and heavy hex head bolts

### ➤ Square and heavy square head bolts

# Adhesive Anchoring Selection Guide



## Solid Concrete Applications



Doweling into Concrete with Rebar

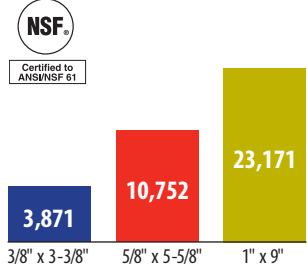

Fastening to Concrete with Threaded Rod

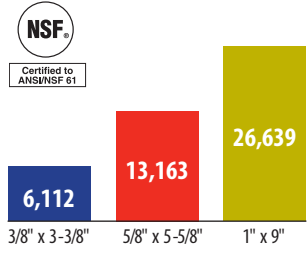
PRODUCT SYSTEMS	KEY FEATURES	PROPERTIES	STRENGTH DESIGN PERFORMANCE <sup>1</sup>																					
<p><b>A7+ The Most Versatile Quick Cure</b></p> <p>Works in more applications than the competition</p> <p>5 fluid oz. (150 ml) kit, 9.5 fluid oz. (280 ml) and 28 fluid oz. (825 ml) cartridges</p> 	<ul style="list-style-type: none"> <li>The only quick-cure ICC-ES listed for use in all wet conditions</li> <li>For use in concrete, block, brick, and clay tile. Solid or hollow base materials</li> <li>Cures in only 45 minutes (at substrate temperature of 70°F/21°C)</li> <li>ICC-ES listing for cracked concrete and seismic applications (ICC-ES ESR 3903)</li> <li>ICC-ES listing for masonry applications (ICC-ES ESR 3951)</li> <li>No drip formula that allows direct-injection overhead installation</li> <li>18 month shelf life</li> <li>NSF/ANSI 61</li> </ul>	<table border="1"> <thead> <tr> <th>BASE MATERIAL (F°/C°)</th> <th>GEL/WORKING TIME</th> <th>FULL CURE TIME</th> </tr> </thead> <tbody> <tr> <td>110°/ 43°</td> <td>1.5 minutes</td> <td>45 minutes</td> </tr> <tr> <td>90°/ 32°</td> <td>3 minutes</td> <td>45 minutes</td> </tr> <tr> <td>70°/ 21°</td> <td>5 minutes</td> <td>45 minutes</td> </tr> <tr> <td>50°/ 10°</td> <td>15 minutes</td> <td>90 minutes</td> </tr> <tr> <td>30°/ -1°</td> <td>35 minutes</td> <td>4 hours</td> </tr> <tr> <td>14°/ -10°</td> <td>35 minutes</td> <td>24 hours</td> </tr> </tbody> </table>	BASE MATERIAL (F°/C°)	GEL/WORKING TIME	FULL CURE TIME	110°/ 43°	1.5 minutes	45 minutes	90°/ 32°	3 minutes	45 minutes	70°/ 21°	5 minutes	45 minutes	50°/ 10°	15 minutes	90 minutes	30°/ -1°	35 minutes	4 hours	14°/ -10°	35 minutes	24 hours	<p>NSF Certified to ANS/NSF 61</p> 
BASE MATERIAL (F°/C°)	GEL/WORKING TIME	FULL CURE TIME																						
110°/ 43°	1.5 minutes	45 minutes																						
90°/ 32°	3 minutes	45 minutes																						
70°/ 21°	5 minutes	45 minutes																						
50°/ 10°	15 minutes	90 minutes																						
30°/ -1°	35 minutes	4 hours																						
14°/ -10°	35 minutes	24 hours																						
<p><b>C6+ For the Most Demanding Jobs</b></p> <p>Red Head's highest strength adhesive</p> <p>MADE IN USA WITH U.S. AND GLOBAL MATERIALS</p> <p>15.2 fluid oz. (450 ml) cartridges and 30.4 fluid oz. (900 ml) cartridges</p> 	<ul style="list-style-type: none"> <li>At least 25% stronger than the old C6+ formulation for threaded rod in cracked concrete and with seismic conditions</li> <li>Fastest cure time in its class, curing in just 2.75 hours at 90°F and in only 2 hours at 110°F!</li> <li>ICC-ES listing for concrete (uncracked and cracked concrete, and seismic conditions) and masonry</li> <li>ICC-ES listing for use in core-drill holes, even in cracked concrete</li> <li>Can be used in oversized holes</li> <li>Can be used in core drilled holes</li> <li>Can be used in all wet conditions (saturated, water-filled, and submerged)</li> <li>European fire approval</li> <li>24 month shelf life</li> <li>NSF/ANSI 61</li> </ul>	<table border="1"> <thead> <tr> <th>BASE MATERIAL (F°/C°)</th> <th>GEL/WORKING TIME</th> <th>FULL CURE TIME</th> </tr> </thead> <tbody> <tr> <td>110°/ 43°</td> <td>10 minutes</td> <td>2 hours</td> </tr> <tr> <td>90°/ 32°</td> <td>14 minutes</td> <td>2.75 hours</td> </tr> <tr> <td>70°/ 21°</td> <td>16 minutes</td> <td>6.5 hours</td> </tr> <tr> <td>50°/ 13°</td> <td>30 minutes</td> <td>24 hours</td> </tr> <tr> <td>40°/ 7°</td> <td>46 minutes</td> <td>48 hours</td> </tr> </tbody> </table>	BASE MATERIAL (F°/C°)	GEL/WORKING TIME	FULL CURE TIME	110°/ 43°	10 minutes	2 hours	90°/ 32°	14 minutes	2.75 hours	70°/ 21°	16 minutes	6.5 hours	50°/ 13°	30 minutes	24 hours	40°/ 7°	46 minutes	48 hours	<p>NSF Certified to ANS/NSF 61</p> 			
BASE MATERIAL (F°/C°)	GEL/WORKING TIME	FULL CURE TIME																						
110°/ 43°	10 minutes	2 hours																						
90°/ 32°	14 minutes	2.75 hours																						
70°/ 21°	16 minutes	6.5 hours																						
50°/ 13°	30 minutes	24 hours																						
40°/ 7°	46 minutes	48 hours																						

<sup>1</sup>Diameter x Embedment in 4000 psi concrete. All loads given in pounds. Calculated using the ICC-ES threaded rod data in uncracked, dry concrete with periodic inspection. Temperature range A.

\*Red head A7+ replaced Epcon A7 and S7. Red Head C6+ replaced Epcon C6+, and Red Head G5+ replaced Epcon G5. For more information on the retired adhesives (Epcon A7, S7, C6+ and G5), please visit [www.itwredhead.com](http://www.itwredhead.com)

# Hollow Base Material Applications

Use the following accessories with the A7+ adhesive anchoring system for all of your hollow base material applications.

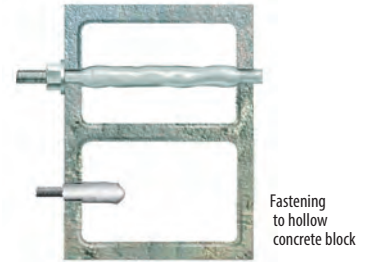
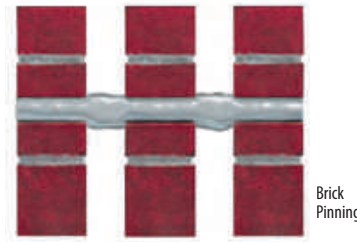

SYSTEM ACCESSORIES	KEY FEATURES	ULTIMATE TENSILE <sup>1,2</sup> PERFORMANCE (LBS.)				
<h3>Umbrella Anchor</h3> <p>Umbrella Anchor</p> <p>Makes it possible to use adhesive for fastening to the face of hollow block or tile (see page 60-61)</p>	<ul style="list-style-type: none"> <li>Highest hold in hollow block</li> <li>1/4", 3/8", or 1/2" rods</li> <li>Fasten to front face of blocks</li> <li>Creates large bearing surface inside block to achieve high loads</li> </ul>	<p><b>A7+</b></p> <table border="1"> <tr> <td>3,558</td> <td>3,558</td> </tr> <tr> <td>3/8"</td> <td>1/2"</td> </tr> </table>	3,558	3,558	3/8"	1/2"
3,558	3,558					
3/8"	1/2"					
<h3>Nylon Screen Tubes</h3> <p>Makes it possible to use adhesive for fastening to hollow block or brick walls (see page 63)</p>	<ul style="list-style-type: none"> <li>3/8" to 3/4" diameter sizes</li> <li>30%-50% lower cost than stainless screens</li> <li>Special design makes screens easier to insert through block or brick</li> <li>Does not get bent or crushed</li> <li>Corrosion resistant</li> </ul>	<p><b>A7+</b></p> <table border="1"> <tr> <td>2,360</td> <td>2,647</td> </tr> <tr> <td>3/8" x 8"</td> <td>3/4" x 8"</td> </tr> </table>	2,360	2,647	3/8" x 8"	3/4" x 8"
2,360	2,647					
3/8" x 8"	3/4" x 8"					
<h3>Stainless Steel Screen Tubes</h3> <p>Makes it possible to use adhesive for fastening to hollow block or brick walls (see page 63)</p>	<ul style="list-style-type: none"> <li>1/4" &amp; 3/4" diameter sizes</li> <li>Corrosion resistant</li> </ul>	<p><b>A7+</b></p> <table border="1"> <tr> <td>2,360</td> <td>2,647</td> </tr> <tr> <td>3/8" x 8"</td> <td>3/4" x 8"</td> </tr> </table>	2,360	2,647	3/8" x 8"	3/4" x 8"
2,360	2,647					
3/8" x 8"	3/4" x 8"					
<h3>Stainless Steel Short Screen Tubes</h3> <p>Makes it possible to use adhesive for fastening to the face of hollow block or tile (see page 61)</p>	<ul style="list-style-type: none"> <li>1/4", 3/8", 1/2", 5/8" diameter sizes</li> <li>Fasten to front face of block</li> <li>Anchor remains perpendicular in wall</li> </ul>	<p><b>A7+</b></p> <table border="1"> <tr> <td>2,458</td> <td>2,543</td> </tr> <tr> <td>1/2"</td> <td>5/8"</td> </tr> </table>	2,458	2,543	1/2"	5/8"
2,458	2,543					
1/2"	5/8"					

<sup>1</sup>Testing performed in hollow concrete block.    <sup>2</sup>Diameter x Embedment.

# A7+

## The Most Versatile Quick Cure Adhesive



A7P-10



A7P-28

### APPLICATIONS / USES

- Concrete dowelling (slabs, walls, columns)
- Steel framing (columns, beams, ledgers)
- Brick pinning and CMU reinforcement
- Architectural metal fastening (railings, signage)
- Mechanical, electrical, and plumbing attachment
- Vibratory equipment anchoring
- Overhead and horizontal anchors

### DESCRIPTION

## Quick Curing Hybrid Epoxy Adhesive

RED HEAD A7+ is a high-strength, fast-cure adhesive that is designed to securely anchor threaded rod and rebar to cured concrete and masonry. A7+ is one of the most versatile anchoring solutions on the market, suitable for use in an extremely wide range of applications and environmental conditions.

- The only quick-cure ICC-ES listed for use in all wet conditions
- For use in concrete, block, brick, and clay tile. Solid or hollow base materials
- Cures in only 45 minutes (at substrate temperature of 70°F/21°C)
- ICC-ES listed for cracked concrete and seismic applications (ICC-ES ESR 3903)
- ICC-ES listed for masonry applications (ICC-ES ESR 3951)
- No drip formula that allows direct-injection overhead installation
- Low odor - suitable for use indoors and in occupied buildings
- 18-month storage life minimizes waste and risk of using expired product
- Rugged cartridge resists breakage due to rough handling or cold temperatures
- Store between 32°F and 95°F in a cool, dry place.

### ADVANTAGES

- All weather formula
- Works in damp holes and underwater applications
- Fast curing time, 45 minutes at 70°F
- ICC-ES Evaluation Report ESR-3903 (Concrete) and ESR-3951 (Masonry)
- NSF 61 Listed, certified for use in conjunction with drinking water systems
- Fast & easy dispensing, even 28 ounce cartridge can be hand dispensed
- Formula for use in solid and hollow base materials

### Curing Times

CONCRETE		ADHESIVE		GEL TIME	FULL CURE TIME
(F°)	(C°)	(F°)	(C°)		
110	43	110	43	1.5 minutes	45 minutes
90	32	90	32	3 minutes	45 minutes
70	21	70	21	5 minutes	45 minutes
50	10	50	10	15 minutes	90 minutes
32	0	32	0	35 minutes	4 hours
14	-10	32	0	35 minutes	24 hours

### Most Competitive Spacing and Edge Distance

NOMINAL ANCHOR DIAMETER (IN.)	MINIMUM SPACING (IN.)	MINIMUM EDGE DISTANCE (IN.)
3/8	15/16	15/16
1/2	1-1/2	1-1/2
5/8	2-1/2	2-1/2
3/4	3	3
7/8	3-1/2	3-1/2
1	4	4
1-1/4	5	5



## INSTALLATION STEPS

### DRILL



### BLOW\*\*

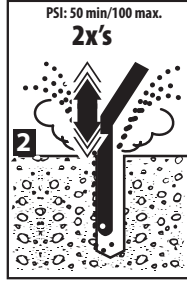

### BRUSH

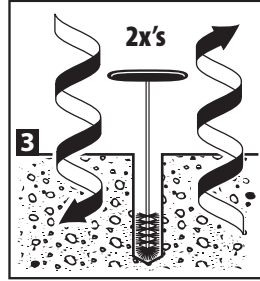

### BLOW\*\*



### DISPENSE

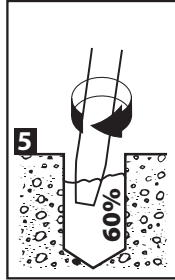

### INSTALL

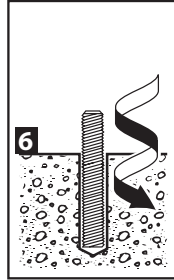

- \* Damp, submerged and underwater applications require 4x's air, 4x's brushing and 4x's air
- \*\* Dust is shown for diagram purposes only. To help mitigate airborne dust and comply with OSHA requirements, we recommend that you either wet the concrete before blowing out the hole, or use a drill dust extractor with your pneumatic air nozzle. We recommend vacuum assisted dust extractors like Milwaukee part numbers 5261-DE or 5317-DE. Call our technical services at (800) 848-5611 for more information.

## PACKAGING

1. Disposable, self-contained cartridge system capable of dispensing both components in the proper mixing ratio
2. Acrylic components dispensed through a static mixing nozzle that thoroughly mixes the material and places the material at the base of the pre-drilled hole
3. Cartridge markings: Include manufacturer's name, batch number and best-used-by date, mix ratio by volume, ANSI hazard classification, and appropriate ANSI handling precautions

All Red Head nozzles can be used with all A7+ cartridges. Choose the nozzle that is right for you depending on hole depth and dispensing needs.

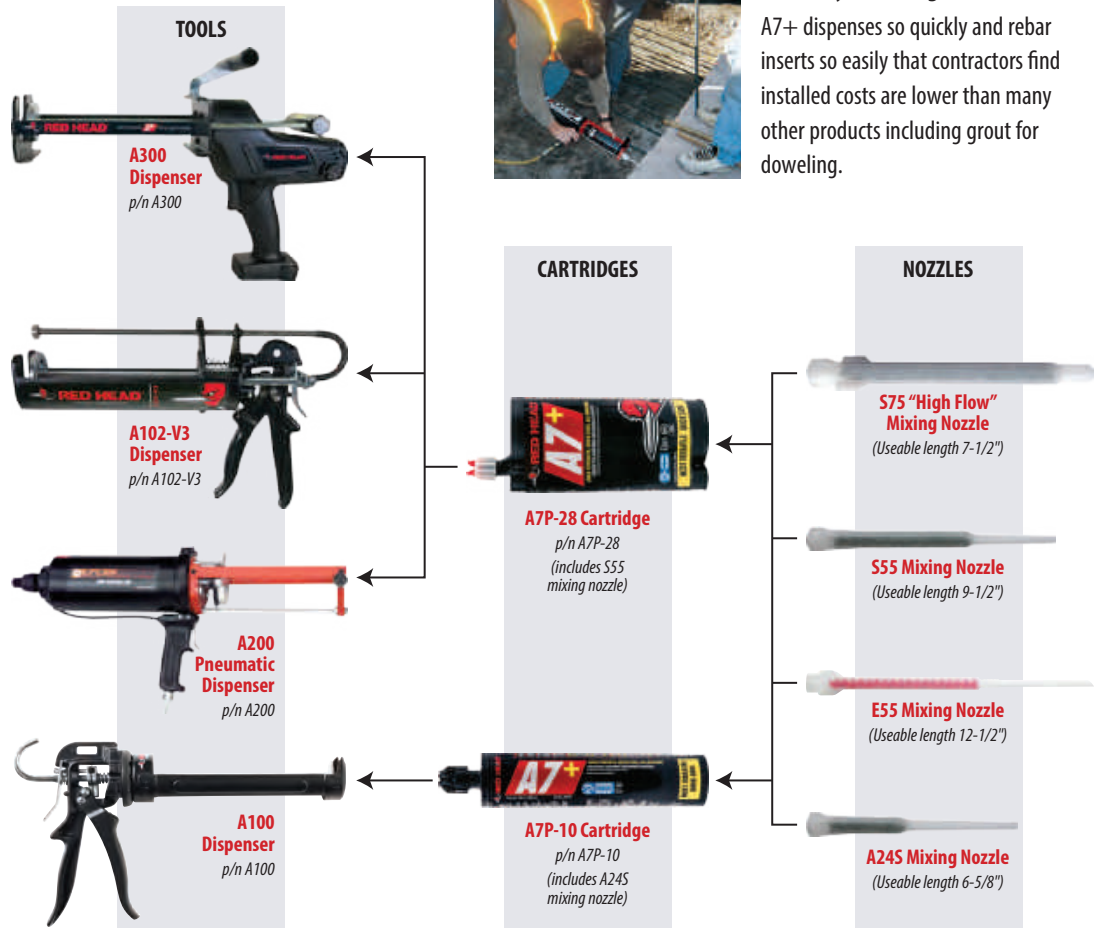

## APPROVALS/LISTINGS

ICC-ES ESR 3903 (Concrete Report)  
 ICC-ES ESR 3951 (Masonry Report)  
 2018, 2015, 2012, 2009, 2006 International Building Code (IBC) Compliant  
 Florida Building Code (FBC)  
 City of Los Angeles (COLA)  
 Extensive Department of Transportation (DOT) Listings  
 NSF/ANSI 61 Approval for use in Drinking Water System Components  
 ASTM C881, Types I, II, IV, and V, Grade 3, Classes A, B, & C (meets Type III except elongation)

For most current approvals and listings please visit:  
[www.itwredhead.com](http://www.itwredhead.com)

## APPLICATIONS



### Water Treatment Facilities



The best-in-class in edge and spacing distance of Red Head A7+ and its ability to work in water have made it a great fit for waste water treatment plants.



### Roadway Doweling

A7+ dispenses so quickly and rebar inserts so easily that contractors find installed costs are lower than many other products including grout for doweling.

## A7P-10 fl. oz. Ordering Information

PART NUMBER	DESCRIPTION	BOX QTY
 A7P-10	9.5 Fluid Ounce Cartridge with A24S Nozzle	6
 A24S	Mixing Nozzle for A7P-10 Cartridge Nozzle diameter fits 3/8" to 5/8" holes (Useable length of nozzle 6-5/8")	24
 A100	Hand Dispenser Designed for A7P-10 Cartridge Contractor Quality 35:1 Thrust Ratio	1

### ESTIMATING TABLES

## A7+

### 9.5 Fluid Ounce Cartridge

### Number of Anchoring Installations per Cartridge\* using Threaded Rod with A7+ in Solid Concrete

ROD (In.)	DRILL HOLE DIA. INCHES	EMBEDMENT DEPTH IN INCHES									
		1	2	3	4	5	6	7	8	9	10
1/4	5/16	371.3	185.6	123.8	92.8	74.3	61.9	53.0	46.4	41.3	37.1
3/8	7/16	189.4	94.7	63.1	47.4	37.9	31.6	27.1	23.7	21.0	18.9
1/2	9/16	114.6	57.3	38.2	28.6	22.9	19.1	16.4	14.3	12.7	11.5
5/8	3/4	64.5	32.2	21.5	16.1	12.9	10.7	9.2	8.1	7.2	6.4
3/4	7/8	47.4	23.7	15.8	11.8	9.5	7.9	6.8	5.9	5.3	4.7
7/8	1	36.3	18.1	12.1	9.1	7.3	6.0	5.2	4.5	4.0	3.6
1	1-1/8	28.6	14.3	9.5	7.2	5.7	4.8	4.1	3.6	3.2	2.9
1-1/4	1-3/8	19.2	9.6	6.4	4.8	3.8	3.2	2.7	2.4	2.1	1.9
1-1/2	1-5/8	13.7	6.9	4.6	3.4	2.7	2.3	2.0	1.7	1.5	1.4

\*The estimated number of anchoring installations per cartridge is based upon calculations of filling the hole 60% full of adhesive per the recommendation in our installation instructions. Hole volumes are calculated using ANSI tolerance carbide tipped drill bits. These estimates do not account for any waste.

### ESTIMATING TABLE

## A7+

### 9.5 Fluid Ounce Cartridge

### Number of Anchoring Installations per Cartridge\* using Rebar with A7+ in Solid Concrete

REBAR	DRILL HOLE DIA. INCHES	EMBEDMENT DEPTH IN INCHES									
		1	2	3	4	5	6	7	8	9	10
#3	7/16	189.4	94.7	63.1	47.4	37.9	31.6	27.1	23.7	21.0	18.9
#4	5/8	92.8	46.4	30.9	23.2	18.6	15.5	13.3	11.6	10.3	9.3
#5	3/4	64.5	32.2	21.5	16.1	12.9	10.7	9.2	8.1	7.2	6.4
#6	7/8	47.4	23.7	15.8	11.8	9.5	7.9	6.8	5.9	5.3	4.7
#7	1	36.3	18.1	12.1	9.1	7.3	6.0	5.2	4.5	4.0	3.6
#8	1-1/8	28.6	14.3	9.5	7.2	5.7	4.8	4.1	3.6	3.2	2.9
#9	1-1/4	23.2	11.6	7.7	5.8	4.6	3.9	3.3	2.9	2.6	2.3
#10	1-1/2	16.1	8.1	5.4	4.0	3.2	2.7	2.3	2.0	1.8	1.6
#11	1-3/4	11.8	5.9	3.9	3.0	2.4	2.0	1.7	1.5	1.3	1.2







\*The estimated number of anchoring installations per cartridge is based upon calculations of filling the hole 60% full of adhesive per the recommendation in our installation instructions. Hole volumes are calculated using ANSI tolerance carbide tipped drill bits. These estimates do not account for any waste.



Call our toll free number 800-848-5611 or visit our web site for the most current product and technical information at [www.itwredhead.com](http://www.itwredhead.com)



## A7P-28 fl. oz. Ordering Information

PART NUMBER	DESCRIPTION	BOX QTY	PART NUMBER	DESCRIPTION	BOX QTY
 A7P-28	28 Fluid Ounce Cartridge A7+ Each cartridge comes with a S55 Nozzle	4	 S55	Mixing Nozzle for A7P-28 Cartridge Nozzle diameter fits holes for 3/8" diameter & larger anchors (Useable length of nozzle 9-1/2")	6
 E55	Mixing Nozzle for A7P-28 and C6P-30 Cartridge. Nozzle diameter fits 3/8" to 5/8" holes. (Useable length of nozzle 12-1/2")	24	 A200	Pneumatic Dispenser for A7P-28 Cartridge	1
 A102-V3	Heavy-Duty 34:1 thrust ratio hand dispenser for A7P-28 cartridge	1	 E25-6	6-Foot Straight Tubing (Used when holes are deeper) (can cut to proper size) (.39 in I.D. x .43 in. O.D.)	24
			 A300	Cordless Battery Dispenser for A7P-28 and C6P-30 Cartridge. Includes one battery and charger. Works with all Milwaukee® M18™ batteries	1

\*See page 65 for nozzle extension tubes and other accessories

### ESTIMATING TABLE

## A7+

### 28 Fluid Ounce Cartridge

### Number of Anchoring Installations per Cartridge\* using Threaded Rod with A7+ in Solid Concrete

Rod (in.)	DRILL HOLE DIA. INCHES	EMBEDMENT DEPTH IN INCHES														
		1	2	3	4	5	6	7	8	9	10	11	12	13	14	15
1/4	5/16	1094.0	547.0	364.7	273.5	218.8	182.3	156.3	136.7	121.6	109.4	99.5	91.2	84.2	78.1	72.9
3/8	7/16	558.2	279.1	186.1	139.5	111.6	93.0	79.7	69.8	62.0	55.8	50.7	46.5	42.9	39.9	37.2
1/2	9/16	337.7	168.8	112.6	84.4	67.5	56.3	48.2	42.2	37.5	33.8	30.7	28.1	26.0	24.1	22.5
5/8	3/4	189.9	95.0	63.3	47.5	38.0	31.7	27.1	23.7	21.1	19.0	17.3	15.8	14.6	13.6	12.7
3/4	7/8	139.5	69.8	46.5	34.9	27.9	23.3	19.9	17.4	15.5	14.0	12.7	11.6	10.7	10.0	9.3
7/8	1	106.8	53.4	35.6	26.7	21.4	17.8	15.3	13.4	11.9	10.7	9.7	8.9	8.2	7.6	7.1
1	1-1/8	84.4	42.2	28.1	21.1	16.9	14.1	12.1	10.6	9.4	8.4	7.7	7.0	6.5	6.0	5.6
1-1/4	1-3/8	56.5	28.3	18.8	14.1	11.3	9.4	8.1	7.1	6.3	5.7	5.1	4.7	4.3	4.0	3.8
1-1/2	1-5/8	40.5	20.2	13.5	10.1	8.1	6.7	5.8	5.1	4.5	4.0	3.7	3.4	3.1	2.9	2.7

\*The estimated number of anchoring installations per cartridge is based upon calculations of filling the hole 60% full of adhesive per the recommendation in our installation instructions. Hole volumes are calculated using ANSI tolerance carbide tipped drill bits. These estimates do not account for any waste.

### ESTIMATING TABLE

## A7+



### 28 Fluid Ounce Cartridge

### Number of Anchoring Installations per Cartridge\* using Rebar with A7+ in Solid Concrete

REBAR	DRILL HOLE DIA. INCHES	EMBEDMENT DEPTH IN INCHES														
		1	2	3	4	5	6	7	8	9	10	11	12	13	14	15
#3	7/16	558.2	279.1	186.1	139.5	111.6	93.0	79.7	69.8	62.0	55.8	50.7	46.5	42.9	39.9	37.2
#4	5/8	273.5	136.7	91.2	68.4	54.7	45.6	39.1	34.2	30.4	27.3	24.9	22.8	21.0	19.5	18.2
#5	3/4	189.9	95.0	63.3	47.5	38.0	31.7	27.1	23.7	21.1	19.0	17.3	15.8	14.6	13.6	12.7
#6	7/8	139.5	69.8	46.5	34.9	27.9	23.3	19.9	17.4	15.5	14.0	12.7	11.6	10.7	10.0	9.3
#7	1	106.8	53.4	35.6	26.7	21.4	17.8	15.3	13.4	11.9	10.7	9.7	8.9	8.2	7.6	7.1
#8	1-1/8	84.4	42.2	28.1	21.1	16.9	14.1	12.1	10.6	9.4	8.4	7.7	7.0	6.5	6.0	5.6
#9	1-1/4	68.4	34.2	22.8	17.1	13.7	11.4	9.8	8.5	7.6	6.8	6.2	5.7	5.3	4.9	4.6
#10	1-1/2	47.5	23.7	15.8	11.9	9.5	7.9	6.8	5.9	5.3	4.7	4.3	4.0	3.7	3.4	3.2
#11	1-3/4	34.9	17.4	11.6	8.7	7.0	5.8	5.0	4.4	3.9	3.5	3.2	2.9	2.7	2.5	2.3

\*The estimated number of anchoring installations per cartridge is based upon calculations of filling the hole 60% full of adhesive per the recommendation in our installation instructions. Hole volumes are calculated using ANSI tolerance carbide tipped drill bits. These estimates do not account for any waste.

## A7P-5 fl. oz. Ordering Information

PART NUMBER	DESCRIPTION	BOX QTY	PART NUMBER	DESCRIPTION	BOX QTY
 A7P-500KIT	Kit with Dispenser Included (1) Cartridge (1) Dispenser (plastic) (1) Nozzle Nozzle diameter fits 3/8" to 5/8" holes	8	 A7P-501KIT	Kit for Standard Caulk Gun (1) Cartridge (1) Sleeve for Caulk Gun (1) Nozzle Nozzle diameter fits 3/8" to 5/8" holes	8

## AVAILABLE WITH YOUR CHOICE OF TWO, EASY DISPENSING SYSTEMS

### A500 PLASTIC DISPENSER

Attaches directly to cartridge allowing for easy hand dispensing. **No extra tools are required.**



### Simple Assembly and Dispensing

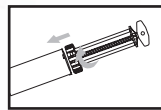

1. Twist-lock dispenser onto cartridge.

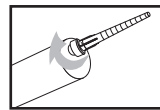

2. Thread nozzle onto cartridge.

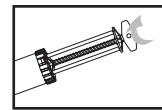

3. Turn lever in order to dispense adhesive.

A7P-500KIT (not shown)

### EASY PACKAGING!

A500 and A501 kits are perfect for both counter or pegboard hanging display.

### A501 CAULKING GUN ADAPTOR

Allows cartridge to work with most standard caulking guns (caulking gun supplied by contractor)



### Simple Assembly and Dispensing

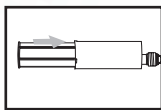

1. Push adaptor tightly against back of cartridge.

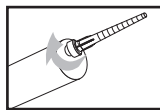

2. Thread nozzle onto cartridge.

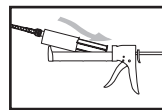

3. Place assembly in caulking gun and dispense adhesive.



A7P-501KIT

## ESTIMATING TABLES

### A7+ 5 Fluid Ounce Cartridge

### Number of Anchoring Installations per Cartridge\* using Threaded Rod with A7+ in Solid Concrete

ROD (in.)	DRILL HOLE DIA. INCHES	EMBEDMENT DEPTH IN INCHES							
		1	2	3	4	5	6	7	8
1/4	5/16	198.9	99.5	66.3	49.7	39.8	33.2	28.4	24.9
3/8	7/16	101.5	50.7	33.8	25.4	20.3	16.9	14.5	12.7
1/2	9/16	61.4	30.7	20.5	15.3	12.3	10.2	8.8	7.7
5/8	3/4	34.5	17.3	11.5	8.6	6.9	5.8	4.9	4.3
3/4	7/8	25.4	12.7	8.5	6.3	5.1	4.2	3.6	3.2
7/8	1	19.4	9.7	6.5	4.9	3.9	3.2	2.8	2.4
1	1-1/8	15.3	7.7	5.1	3.8	3.1	2.6	2.2	1.9

\*The estimated number of anchoring installations per cartridge is based upon calculations of filling the hole 60% full of adhesive per the recommendation in our installation instructions. Hole volumes are calculated using ANSI tolerance carbide tipped drill bits. These estimates do not account for any waste.



Call our toll free number 800-848-5611 or visit our web site for the most current product and technical information at [www.itwredhead.com](http://www.itwredhead.com)



## ESTIMATING TABLES

### A7+ 5 Fluid Ounce Cartridge

### Number of Anchoring Installations per Cartridge\* using Rebar with A7+ in Solid Concrete

REBAR	DRILL HOLE DIA. INCHES	EMBEDMENT DEPTH IN INCHES							
		1	2	3	4	5	6	7	8
#3	7/16	101.5	50.7	33.8	25.4	20.3	16.9	14.5	12.7
#4	5/8	49.7	24.9	16.6	12.4	9.9	8.3	7.1	6.2
#5	3/4	34.5	17.3	11.5	8.6	6.9	5.8	4.9	4.3
#6	7/8	25.4	12.7	8.5	6.3	5.1	4.2	3.6	3.2
#7	1	19.4	9.7	6.5	4.9	3.9	3.2	2.8	2.4
#8	1-1/8	15.3	7.7	5.1	3.8	3.1	2.6	2.2	1.9
#9	1-1/4	12.4	6.2	4.1	3.1	2.5	2.1	1.8	1.6

\*The estimated number of anchoring installations per cartridge is based upon calculations of filling the hole 60% full of adhesive per the recommendation in our installation instructions. Hole volumes are calculated using ANSI tolerance carbide tipped drill bits. These estimates do not account for any waste.

## PERFORMANCE TABLE

### A7+ The Most Versatile Quick-Cure

### Threaded Rod Ultimate Tension and Shear Loads<sup>1,2,3</sup> Installed in Solid Concrete

THREADED ROD DIAMETER		DRILL HOLE DIAMETER		MAX. CLAMPING FORCE AFTER PROPER CURE		EMBEDMENT IN CONCRETE		2000 PSI (13.8 MPa) CONCRETE				4000 PSI (27.6 MPa) CONCRETE			
								ULTIMATE TENSION		ULTIMATE SHEAR		ULTIMATE TENSION		ULTIMATE SHEAR	
in.	(mm)	in.	(mm)	ft.-lbs	(Nm)	in.	(mm)	lbs.	(kN)	lbs.	(kN)	lbs.	(kN)	lbs.	(kN)
3/8	(9.5)	7/16	(11.1)	9	(12)	1-1/2	(38.1)	N/A	N/A	N/A	N/A	3,734	(16.6)	4,126	(18.3)
						3-3/8	(85.7)	5,852	(26.0)	5,220	(23.2)	10,977	(48.8)	5,220	(23.2)
						4-1/2	(114.3)	7,729	(34.4)	5,220	(23.2)	11,661	(51.9)	5,220	(23.2)
1/2	(12.7)	9/16	(14.3)	16	(21)	2	(50.8)	N/A	N/A	N/A	N/A	6,022	(26.8)	8,029	(35.7)
						4-1/2	(114.3)	10,798	(48.0)	8,029	(35.7)	17,162	(76.3)	8,029	(35.7)
						6	(152.4)	14,210	(63.2)	8,029	(35.7)	17,372	(77.3)	8,029	(35.7)
5/8	(15.9)	3/4	(19.1)	47	(63)	2-1/2	(63.5)	N/A	N/A	N/A	N/A	7,330	(32.6)	11,256	(50.1)
						5-5/8	(142.9)	16,417	(73.0)	15,967	(71.0)	26,504	(117.9)	15,967	(71.0)
						7-1/2	(190.5)	18,747	(83.4)	15,967	(71.0)	29,381	(130.7)	15,967	(71.0)
3/4	(19.1)	7/8	(22.2)	70	(95)	3	(76.2)	N/A	N/A	N/A	N/A	8,634	(38.4)	20,126	(89.5)
						6-3/4	(171.5)	18,618	(82.8)	20,126	(89.5)	29,727	(132.2)	20,126	(89.5)
						9	(228.6)	23,934	(106.5)	20,126	(89.5)	37,728	(167.8)	20,126	(89.5)
7/8	(22.2)	1	(25.4)	90	(122)	3-1/2	(88.9)	N/A	N/A	N/A	N/A	13,650	(60.7)	20,920	(92.9)
						7-7/8	(200.0)	N/A	N/A	29,866	(132.9)	44,915	(199.8)	29,866	(132.9)
						10-1/2	(266.7)	36,881	(164.1)	29,866	(132.9)	48,321	(215.0)	29,866	(132.9)
1	(25.4)	1-1/8	(28.6)	110	(149)	4	(101.6)	N/A	N/A	N/A	N/A	16,266	(72.2)	33,152	(147.5)
						9	(228.6)	32,215	(143.3)	37,538	(167.0)	48,209	(214.5)	37,538	(167.0)
						12	(304.8)	46,064	(204.9)	37,538	(167.0)	63,950	(284.5)	37,538	(167.0)
1-1/4	(31.8)	1-3/8	(34.9)	370	(501)	5	(127.0)	N/A	N/A	N/A	N/A	21,838	(97.1)	33,152	(147.5)
						11-1/4	(285.8)	45,962	(204.5)	58,412	(259.8)	56,715	(252.3)	58,412	(259.8)
						15	(381.0)	62,208	(276.7)	58,412	(259.8)	84,385	(375.4)	58,412	(259.8)

1 Allowable working loads for the single installation under static loading should not exceed 25% capacity of the ultimate load. To calculate the allowable load of the anchor, divide the ultimate load by 4.

2 Ultimate load values in 2000 and 4000 psi stone aggregate concrete. Ultimate loads are indicated for the embedment shown in the Embedment in Concrete column. Performance values are based on the use of high strength threaded rod (ASTM A193 Gr. B7). The use of lower strength rods will result in lower ultimate tension and shear loads.

3 Linear interpolation may be used for intermediate spacing and edge distances.

## PERFORMANCE TABLE

**A7+**  
The most Versatile Quick Cure

**Threaded Rod Allowable Tension Loads<sup>1,2</sup>**  
Installed in Solid Concrete

THREADED ROD DIAMETER		DRILL HOLE DIAMETER		MIN. EMBEDMENT DEPTH		ALLOWABLE TENSION LOAD BASED ON ADHESIVE BOND STRENGTH				ALLOWABLE TENSION LOAD BASED ON STEEL STRENGTH					
						2000 PSI (13.8 MPa) CONCRETE		4000 PSI (27.6 MPa) CONCRETE		ASTM A307 (SAE 1018)		ASTM A193 GR. B7 (SAE4140)		ASTM F593 AISI 304 SS	
in.	(mm)	in.	(mm)	in.	(mm)	lbs.	(kN)	lbs.	(kN)	lbs.	(kN)	lbs.	(kN)	lbs.	(kN)
3/8	(9.5)	7/16	(11.1)	1-1/2	(38.1)	N/A	N/A	934	(4.2)	2,080	(9.3)	4,340	(19.3)	3,995	(17.8)
				3-3/8	(85.7)	1,460	(6.5)	2,740	(12.2)	2,080	(9.3)	4,340	(19.3)	3,995	(17.8)
				4-1/2	(114.3)	1,930	(8.6)	2,915	(13.0)	2,080	(9.3)	4,340	(19.3)	3,995	(17.8)
1/2	(12.7)	9/16	(14.3)	2	(50.8)	N/A	N/A	1,505	(6.7)	3,730	(16.6)	7,780	(34.6)	7,155	(31.8)
				4-1/2	(114.3)	2,700	(12.0)	4,290	(19.1)	3,730	(16.6)	7,780	(34.6)	7,155	(31.8)
				6	(152.4)	3,550	(15.8)	4,340	(19.3)	3,730	(16.6)	7,780	(34.6)	7,155	(31.8)
5/8	(15.9)	3/4	(19.1)	2-1/2	(63.5)	N/A	N/A	1,832	(8.2)	5,870	(26.1)	12,230	(54.4)	11,250	(50.0)
				5-5/8	(142.9)	4,100	(18.3)	6,625	(29.5)	5,870	(26.1)	12,230	(54.4)	11,250	(50.0)
				7-1/2	(190.5)	4,685	(20.8)	7,345	(32.7)	5,870	(26.1)	12,230	(54.4)	11,250	(50.0)
3/4	(19.1)	7/8	(22.2)	3	(76.2)	N/A	N/A	2,158	(9.6)	8,490	(37.8)	17,690	(78.7)	14,860	(66.1)
				6-3/4	(171.5)	4,655	(20.7)	7,430	(33.1)	8,490	(37.8)	17,690	(78.7)	14,860	(66.1)
				9	(228.6)	5,980	(26.6)	9,430	(42.0)	8,490	(37.8)	17,690	(78.7)	14,860	(66.1)
7/8	(22.2)	1	(25.4)	3-1/2	(88.9)	N/A	N/A	3,413	(15.2)	11,600	(51.6)	25,510	(113.5)	20,835	(92.7)
				7-7/8	(200.0)	N/A	N/A	11,230	(49.9)	11,600	(51.6)	25,510	(113.5)	20,835	(92.7)
				10-1/2	(266.7)	9,220	(41.0)	12,080	(53.7)	11,600	(51.6)	25,510	(113.5)	20,834	(92.7)
1	(25.4)	1-1/8	(28.6)	4	(101.6)	N/A	N/A	4,067	(18.1)	15,180	(67.5)	31,620	(140.7)	26,560	(118.1)
				9	(228.6)	8,050	(35.8)	12,050	(53.6)	15,180	(67.5)	31,620	(140.7)	26,560	(118.1)
				12	(304.8)	11,515	(51.2)	15,985	(71.1)	15,180	(67.5)	31,620	(140.7)	26,560	(118.1)
1-1/4	(31.8)	1-3/8	(34.9)	5	(127.0)	N/A	N/A	5,460	(24.3)	23,800	(105.9)	49,580	(220.6)	34,670	(154.2)
				11-1/4	(285.8)	11,490	(51.1)	14,175	(63.1)	23,800	(105.9)	49,580	(220.6)	34,670	(154.2)
				15	(381.0)	15,550	(69.2)	21,095	(93.8)	23,800	(105.9)	49,580	(220.6)	34,670	(154.2)

1 Use lower value of either bond or steel strength for allowable tensile load.

2 Larger rods and/or deeper holes may be used. However, it may not be covered by current codes.

## PERFORMANCE TABLE

**A7+**  
The most Versatile Quick Cure

**Threaded Rod Allowable Shear Loads<sup>1,2</sup>**  
Installed in Solid Concrete

THREADED ROD DIAMETER		DRILL HOLE DIAMETER		MIN. EMBEDMENT DEPTH		ALLOWABLE SHEAR LOAD BASED ON CONCRETE STRENGTH				ALLOWABLE SHEAR LOAD BASED ON STEEL STRENGTH					
						2000 PSI (13.8 MPa) CONCRETE		4000 PSI (27.6 MPa) CONCRETE		ASTM A307 (SAE 1018)		ASTM A193 GR. B7 (SAE4140)		ASTM F593 AISI 304 SS	
in.	(mm)	in.	(mm)	in.	(mm)	lbs.	(kN)	lbs.	(kN)	lbs.	(kN)	lbs.	(kN)	lbs.	(kN)
3/8	(9.5)	7/16	(11.1)	1-1/2	(38.1)	N/A	N/A	1,031	(4.6)	1,040	(4.6)	2,170	(9.7)	1,995	(8.9)
				3-3/8	(85.7)	1,305	(5.8)	1,305	(5.8)	1,040	(4.6)	2,170	(9.7)	1,995	(8.9)
1/2	(12.7)	9/16	(14.3)	2	(50.8)	N/A	N/A	2,005	(8.9)	1,870	(8.3)	3,895	(17.3)	3,585	(15.9)
				4-1/2	(114.3)	2,005	(8.9)	2,005	(8.9)	1,870	(8.3)	3,895	(17.3)	3,585	(15.9)
5/8	(15.9)	3/4	(19.1)	2-1/2	(63.5)	N/A	N/A	2,814	(12.5)	2,940	(13.1)	6,125	(27.2)	5,635	(25.1)
				5-5/8	(142.9)	3,990	(17.8)	3,990	(17.8)	2,940	(13.1)	6,125	(27.2)	5,635	(25.1)
3/4	(19.1)	7/8	(22.2)	3	(76.2)	N/A	N/A	5,030	(22.4)	4,250	(18.9)	8,855	(39.4)	7,440	(33.1)
				6-3/4	(171.5)	5,030	(22.4)	5,030	(22.4)	4,250	(18.9)	8,855	(39.4)	7,440	(33.1)
7/8	(22.2)	1	(25.4)	3-1/2	(88.9)	N/A	N/A	5,230	(23.3)	5,800	(25.8)	12,760	(56.8)	10,730	(47.7)
				7-7/8	(200.0)	7,465	(33.2)	7,465	(33.2)	5,800	(25.8)	12,760	(56.8)	10,730	(47.7)
1	(25.4)	1-1/8	(28.6)	4	(101.6)	N/A	N/A	8,288	(36.9)	7,590	(33.8)	15,810	(70.3)	13,285	(59.1)
				9	(228.6)	9,385	(41.7)	9,385	(41.7)	7,590	(33.8)	15,810	(70.3)	13,285	(59.1)
1-1/4	(31.8)	1-3/8	(34.9)	5	(127.0)	N/A	N/A	8,288	(36.9)	11,900	(52.9)	24,790	(100.3)	18,840	(83.8)
				11-1/4	(285.8)	14,600	(64.9)	14,600	(64.9)	11,900	(52.9)	24,790	(100.3)	18,840	(83.8)

1 Use lower value of either concrete or steel strength for allowable shear load.

2 Larger rods and/or deeper holes may be used. However, it may not be covered by current codes.



Call our toll free number 800-848-5611 or visit our web site for the most current product and technical information at [www.itwredhead.com](http://www.itwredhead.com)



## PERFORMANCE TABLE

# A7+

The Most Versatile Quick-Cure

**Rebar Ultimate Tension Loads<sup>1,2,3</sup>  
Installed in Solid Concrete**

REINFORCING BAR DIAMETER		EMBEDMENT IN CONCRETE		2000 PSI (13.8 MPa) CONCRETE ULTIMATE TENSION		4000 PSI (27.6 MPa) CONCRETE ULTIMATE TENSION		ULTIMATE TENSILE AND YIELD STRENGTH: GRADE 60 REBAR			
								MINIMUM YIELD STRENGTH		MINIMUM ULTIMATE TENSILE STRENGTH	
in.	(mm)	in.	(mm)	lbs.	(kN)	lbs.	(kN)	lbs.	(kN)	lbs.	(kN)
# 3	(9.5)	3-3/8	(85.7)	6,180	(27.5)	8,324	(37.0)	6,600	(29.4)	9,900	(44.0)
		4-1/2	(114.3)	7,560	(33.6)	11,418	(50.8)	6,600	(29.4)	9,900	(44.0)
# 4	(12.7)	4-1/2	(114.3)	9,949	(44.3)	16,657	(74.1)	12,000	(53.4)	18,000	(80.1)
		6	(152.4)	15,038	(66.9)	17,828	(79.3)	12,000	(53.4)	18,000	(80.1)
# 5	(15.9)	5-5/8	(142.9)	14,012	(62.3)	20,896	(93.0)	18,600	(82.7)	27,900	(124.1)
		7-1/2	(190.5)	16,718	(74.4)	26,072	(116.0)	18,600	(82.7)	27,900	(124.1)
# 6	(19.1)	6-3/4	(171.5)	21,247	(94.5)	26,691	(118.7)	26,400	(117.4)	39,600	(176.2)
		9	(228.6)	33,325	(148.2)	37,425	(166.5)	26,400	(117.4)	39,600	(176.2)
# 7	(22.2)	7-7/8	(200.0)	N/A	N/A	40,374	(179.6)	36,000	(160.1)	54,000	(240.2)
		10-1/2	(266.7)	38,975	(173.4)	46,050	(204.8)	36,000	(160.1)	54,000	(240.2)
# 8	(25.4)	9	(228.6)	35,600	(158.4)	47,311	(210.5)	47,400	(210.9)	71,100	(316.3)
		12	(304.8)	41,010	(182.4)	66,140	(294.2)	47,400	(210.9)	71,100	(316.3)
# 9	(28.6)	10-1/8	(257.2)	N/A	N/A	57,221	(254.5)	60,000	(266.9)	90,000	(400.4)
		13-1/2	(342.9)	N/A	N/A	79,966	(355.7)	60,000	(266.9)	90,000	(400.4)
# 10	(31.8)	11-1/4	(285.8)	49,045	(218.2)	73,091	(325.1)	76,200	(339.0)	114,300	(508.5)
		15	(381.0)	69,079	(307.3)	83,295	(370.5)	76,200	(339.0)	114,300	(508.5)
# 11	(34.9)	12-3/8	(314.3)	63,397	(282.0)	75,047	(333.8)	93,600	(416.4)	140,400	(624.6)
		16-1/2	(419.1)	81,707	(363.5)	91,989	(409.2)	93,600	(416.4)	140,400	(624.6)

1 Allowable working loads for the single installation under static loading should not exceed 25% capacity or the allowable load of the anchor rod.

2 Ultimate load values in 2000 and 4000 psi stone aggregate concrete. Ultimate loads are indicated for the embedment shown in the Embedment in Concrete column. Performance values are based on the use of minimum Grade 60 reinforcing bar. The use of lower strength rods will result in lower ultimate tension loads.

3 SHEAR DATA: Provided the distance from the rebar to the edge of the concrete member exceeds 1.25 times the embedment depth of the rebar, calculate the ultimate shear load for the rebar anchorage as 60% of the ultimate tensile strength of the rebar.

4 Larger rods and/or deeper holes may be used. However, it may not be covered by current codes.

## PERFORMANCE TABLE

# A7+

The Most Versatile Quick-Cure

**Threaded Rod Recommended Edge Distance Requirements  
for Tension Loads Installed in Solid Concrete**

ANCHOR DIAMETER		EMBEDMENT DEPTH		CRITICAL EDGE DISTANCE (100% LOAD CAPACITY)		INTERPOLATED EDGE DISTANCE (90% LOAD CAPACITY)		INTERPOLATED EDGE DISTANCE (80% LOAD CAPACITY)		MINIMUM EDGE DISTANCE (70% LOAD CAPACITY)	
				in.	(mm)	in.	(mm)	in.	(mm)	in.	(mm)
3/8	(9.5)	3-3/8	(85.7)	2-1/2	(63.5)	1-15/16	(49.2)	1-3/8	(34.9)	13/16	(26.2)
		4-1/2	(114.3)	3-3/8	(85.7)	2-5/8	(66.7)	1-7/8	(47.6)	1-1/8	(28.6)
1/2	(12.7)	4-1/2	(114.3)	3-3/8	(85.7)	2-5/8	(66.7)	1-7/8	(47.6)	1-1/8	(28.6)
		6	(152.4)	4-1/2	(114.3)	3-1/2	(88.9)	2-1/2	(63.5)	1-1/2	(38.1)
5/8	(15.9)	5-5/8	(142.9)	4-3/16	(106.4)	3-1/4	(82.6)	2-5/16	(58.7)	1-3/8	(34.9)
		7-1/2	(190.5)	5-5/8	(142.9)	4-3/8	(111.1)	3-1/8	(79.4)	1-7/8	(47.6)
3/4	(19.1)	6-3/4	(171.5)	5-1/16	(128.6)	3-15/16	(100.0)	2-13/16	(71.4)	1-5/8	(15.9)
		9	(228.6)	6-3/4	(171.5)	5-1/4	(133.4)	3-3/4	(95.3)	2-1/4	(57.2)
1	(25.4)	9	(228.6)	6-3/4	(171.5)	5-1/4	(133.4)	3-3/4	(95.3)	2-1/4	(57.2)
		12	(304.8)	9	(228.6)	7	(177.8)	5	(127.0)	3	(76.2)
1-1/4	(31.8)	11-1/4	(285.8)	8-7/16	(214.3)	6-9/16	(166.7)	4-3/4	(120.7)	2-7/8	(73.0)
		15	(381.0)	11-1/4	(285.8)	8-3/4	(222.2)	6-1/4	(158.8)	3-3/4	(95.3)

## PERFORMANCE TABLE

# A7+

The Most Versatile Quick-Cure

**Threaded Rod Recommended Edge Distance Requirements for Shear Loads Installed in Solid Concrete**

ANCHOR DIAMETER		EMBEDMENT DEPTH (100% LOAD CAPACITY)		CRITICAL EDGE DISTANCE (100% LOAD CAPACITY)		INTERPOLATED EDGE DISTANCE (80% LOAD CAPACITY)		INTERPOLATED EDGE DISTANCE (50% LOAD CAPACITY)		MINIMUM EDGE DISTANCE (10% LOAD CAPACITY)	
in.	(mm)	in.	(mm)	in.	(mm)	in.	(mm)	in.	(mm)	in.	(mm)
3/8	(9.5)	3-3/8	(85.7)	4-3/16	(106.4)	3-7/16	(87.3)	2-5/16	(58.7)	13/16	(20.6)
1/2	(12.7)	4-1/2	(114.3)	5-5/8	(142.9)	4-5/8	(117.5)	3-1/8	(79.4)	1-1/8	(28.6)
5/8	(15.9)	5-5/8	(142.9)	7	(177.8)	5-3/4	(146.1)	3-1/8	(79.4)	1-3/8	(34.9)
3/4	(19.1)	6-3/4	(171.5)	8-7/16	(214.2)	6-15/16	(176.2)	4-5/8	(117.5)	1-5/8	(41.3)
1	(25.4)	9	(228.6)	11-1/4	(285.8)	9-1/4	(235.0)	6-1/4	(158.8)	2-1/4	(57.2)
1-1/4	(31.8)	11-1/4	(285.8)	14-1/16	(357.2)	11-5/8	(295.3)	7-7/8	(200.0)	2-7/8	(73.0)

## PERFORMANCE REFERENCE TABLE

# A7+

The Most Versatile Quick-Cure

**Allowable Stress Design Reference Tables**

### Threaded Rod and Rebar Installation in Solid Concrete Edge / Spacing Distance Load Factor Summary<sup>1,2</sup>

#### LOAD FACTOR

##### Critical Edge Distance—Tension

100% Tension Load

→ 0.75 x Anchor Embedment

##### Minimum Edge Distance—Tension

70% Tension Load

→ 0.25 x Anchor Embedment

##### Critical Edge Distance—Shear

100% Shear Load

→ 1.25 x Anchor Embedment

##### Minimum Edge Distance—Shear

10% Shear Load

→ 0.25 x Anchor Embedment

#### LOAD FACTOR

##### Critical Spacing—Tension

100% Tension Load

→ 1.25 x Anchor Embedment

##### Minimum Spacing—Tension

80% Tension Load

→ 0.25 x Anchor Embedment

##### Critical Spacing—Shear

100% Shear Load

→ 1.25 x Anchor Embedment

##### Minimum Spacing—Shear

25% Shear Load

→ 0.25 x Anchor Embedment

#### DISTANCE FROM EDGE OF CONCRETE

#### DISTANCE FROM ANOTHER ANCHOR

- Use linear interpolation for load factors at edge distances or spacing distances between critical and minimum.
- Anchors are affected by multiple combination of spacing and/or edge distance loading and direction of the loading. Use the product of tension and shear loading factors in design.

### Combined Tension and Shear Loading—for A7+/C6+/G5+ Adhesive Anchors

Allowable loads for anchors under tension and shear loading at the same time (combined loading) will be lower than the allowable loads for anchors subjected to 100% tension or 100% shear. Use the following equation to evaluate anchors in combined loading conditions:

$$\left(\frac{N_a}{N_s}\right)^{5/3} + \left(\frac{V_a}{V_s}\right)^{5/3} \leq 1$$

$N_a$  = Applied Service Tension Load

$N_s$  = Allowable Tension Load

$V_a$  = Applied Service Shear Load

$V_s$  = Allowable Shear Load



Call our toll free number 800-848-5611 or visit our web site for the most current product and technical information at [www.itwredhead.com](http://www.itwredhead.com)





# STRENGTH DESIGN TABLE

## A7+

The Most Versatile Quick-Cure

**Threaded Rod Tension (lbf) and Shear (lbf) Loads  
in Uncracked Concrete<sup>1,2,3,4</sup> ASTM A193 B7**

Anchor Diameter (in.)	Embedment Depth (in.)	Tension (lbf)					Shear (lbf)
		2500 psi	3000 psi	4000 psi	5000 psi	6000 psi - 8000 psi	2500 psi - 8000 psi
3/8	3-3/8	3,870	3,870	3,870	3,870	3,870	3,775
	4-1/2	5,160	5,160	5,160	5,160	5,160	3,775
	7-1/2	7,265	7,265	7,265	7,265	7,265	3,775
1/2	4-1/2	6,880	6,880	6,880	6,880	6,880	6,915
	6	9,175	9,175	9,175	9,175	9,175	6,915
	10	13,305	13,305	13,305	13,305	13,305	6,915
5/8	5-5/8	10,405	10,750	10,750	10,750	10,750	11,015
	7-1/2	14,335	14,335	14,335	14,335	14,335	11,015
	12-1/2	21,185	21,185	21,185	21,185	21,185	11,015
3/4	6-3/4	13,675	14,980	15,480	15,480	15,480	16,305
	9	20,640	20,640	20,640	20,640	20,640	16,305
	15	31,355	31,355	31,355	31,355	31,355	16,305
7/8	7-7/8	17,235	17,740	17,740	17,740	17,740	22,505
	10-1/2	23,650	23,650	23,650	23,650	23,650	22,505
	17-1/2	39,420	39,420	39,420	39,420	39,420	22,505
1	9	21,060	23,070	23,170	23,170	23,170	29,525
	12	30,890	30,890	30,890	30,890	30,890	29,525
	20	51,490	51,490	51,490	51,490	51,490	29,525
1-1/4	11-1/4	29,430	32,240	37,225	41,620	42,785	47,240
	15	45,310	49,635	57,045	57,045	57,045	47,240
	25	90,855	90,855	90,855	90,855	90,855	47,240

1 Tabulated values are for estimation purposes only and should not be used for design (please use our free TruSpec anchorage design software at [www.itwredhead.com](http://www.itwredhead.com))

2 Tabulated values represent strength design per ACI 318 for a single anchor in adequate concrete thickness, not near an edge nor adjacent anchorage, and not for sustained loading.

3 Bond strengths used in calculations are for dry, uncracked concrete with periodic inspection

4 Bond strengths used in calculations are for Temperature Range A (maximum long term temperature of 110F, maximum short term temperature of 142F).

## STRENGTH DESIGN TABLE

# A7+

The Most Versatile Quick-Cure

**Threaded Rod Tension (lbf) and Shear (lbf) Loads  
in 4,000 psi Uncracked Concrete<sup>1,2,3,4</sup>**

Anchor Diameter (in.)	Embedment Depth (in.)	ASTM A193 B7 Threaded Rod		Stainless Steel F593		Carbon Steel A36	
		Tension (lbf)	Shear (lbf)	Tension (lbf)	Shear (lbf)	Tension (lbf)	Shear (lbf)
3/8	3-3/8	3,870	3,775	3,375	1,755	3,870	2,280
	4-1/2	5,160	3,775	3,375	1,755	4,785	2,280
	7-1/2	7,265	3,775	3,375	1,755	4,785	2,280
1/2	4-1/2	6,880	6,915	6,170	3,210	6,880	4,040
	6	9,175	6,915	6,170	3,210	8,760	4,040
	10	13,305	6,915	6,170	3,210	8,760	4,040
5/8	5-5/8	10,750	11,015	9,830	5,115	10,750	6,440
	7-1/2	14,335	11,015	9,830	5,115	13,955	6,440
	12-1/2	21,185	11,015	9,830	5,115	13,955	6,440
3/4	6-3/4	15,480	16,305	14,550	7,565	15,480	7,610
	9	20,640	16,305	14,550	7,565	16,500	7,610
	15	31,355	16,305	14,550	7,565	16,500	7,610
7/8	7-7/8	17,740	22,505	17,740	10,445	17,740	10,530
	10-1/2	23,650	22,505	20,085	10,445	22,820	10,530
	17-1/2	39,420	22,505	20,085	10,445	22,820	10,530
1	9	23,170	29,525	23,170	13,700	23,170	13,815
	12	30,890	29,525	26,345	13,700	29,935	13,815
	20	51,490	29,525	26,345	13,700	29,935	13,815
1-1/4	11-1/4	37,225	47,240	37,225	21,920	37,225	22,090
	15	57,045	47,240	42,155	21,920	47,865	22,090
	25	90,855	47,240	42,155	21,920	47,865	22,090

1 Tabulated values are for estimation purposes only and should not be used for design (please use our free TruSpec anchorage design software at [www.itwredhead.com](http://www.itwredhead.com))

2 Tabulated values represent strength design per ACI 318 for a single anchor in adequate concrete thickness, not near an edge nor adjacent anchorage, and not for sustained loading.

3 Bond strengths used in calculations are for dry, uncracked concrete with periodic inspection

4 Bond strengths used in calculations are for Temperature Range A (maximum long term temperature of 110F, maximum short term temperature of 142F).



Call our toll free number 800-848-5611 or visit our web site for the most current product and technical information at [www.itwredhead.com](http://www.itwredhead.com)



## STRENGTH DESIGN TABLE

# A7+

The Most Versatile Quick-Cure

**Threaded Rod Tension (lbf) and Shear (lbf) Loads  
in Cracked Concrete<sup>1,2,3,4</sup> ASTM A193 B7**

Anchor Diameter (in.)	Embedment Depth (in.)	Tension (lbf) 2,500-8,000 psi	Shear (lbf) 2,500-8,000 psi
3/8	3-3/8	2,315	3,775
	4-1/2	3,090	3,775
	7-1/2	5,150	3,775
1/2	4-1/2	3,070	6,915
	6	4,095	6,915
	10	6,825	6,915
5/8	5-5/8	5,220	11,015
	7-1/2	6,965	11,015
	12-1/2	11,605	11,015
3/4	6-3/4	7,785	15,365
	9	10,380	16,305
	15	17,300	16,305
7/8	7-7/8	8,270	20,915
	10-1/2	11,030	22,505
	17-1/2	18,385	22,505
1	9	10,185	27,320
	12	13,580	29,525
	20	22,635	29,525
1-1/4	11-1/4	16,795	46,600
	15	22,395	47,240
	25	37,330	47,240

1 Tabulated values are for estimation purposes only and should not be used for design (please use our free TruSpec anchorage design software at [www.itwredhead.com](http://www.itwredhead.com))

2 Tabulated values represent strength design per ACI 318 for a single anchor in adequate concrete thickness, not near an edge nor adjacent anchorage, and not for sustained loading.

3 Bond strengths used in calculations are for dry, cracked concrete with periodic inspection

4 Bond strengths used in calculations are for Temperature Range A (maximum long term temperature of 110F, maximum short term temperature of 142F).

## STRENGTH DESIGN TABLE

# A7+

The Most Versatile Quick-Cure

**Threaded Rod Tension (lbf) and Shear (lbf) Loads  
in 4,000 psi Cracked Concrete<sup>1,2,3,4</sup>**

Anchor Diameter (in.)	Embedment Depth (in.)	ASTM A193 B7 Threaded Rod		Stainless Steel F593		Carbon Steel A36	
		Tension (lbf)	Shear (lbf)	Tension (lbf)	Shear (lbf)	Tension (lbf)	Shear (lbf)
3/8	3-3/8	2,315	3,245	3,375	1,755	3,870	2,280
	4-1/2	3,090	3,775	3,375	1,755	4,785	2,280
	7-1/2	5,150	3,775	3,375	1,755	4,785	2,280
1/2	4-1/2	3,070	4,295	6,170	3,210	6,670	4,040
	6	4,095	5,730	6,170	3,210	8,760	4,040
	10	6,825	6,915	6,170	3,210	8,760	4,040
5/8	5-5/8	5,220	7,310	9,320	5,115	9,320	6,440
	7-1/2	6,965	9,750	9,830	5,115	13,955	6,440
	12-1/2	11,605	11,015	9,830	5,115	13,955	6,440
3/4	6-3/4	7,785	10,895	12,255	7,565	12,255	7,610
	9	10,380	14,530	14,550	7,565	16,500	7,610
	15	17,300	16,305	14,550	7,565	16,500	7,610
7/8	7-7/8	8,270	11,580	15,440	10,445	15,440	10,530
	10-1/2	11,030	15,445	20,085	10,445	22,820	10,530
	17-1/2	18,385	22,505	20,085	10,445	22,820	10,530
1	9	10,185	14,260	18,865	13,700	18,865	13,815
	12	13,580	19,010	26,345	13,700	29,050	13,815
	20	22,635	29,525	26,345	13,700	29,935	13,815
1-1/4	11-1/4	16,795	23,515	26,370	21,920	26,370	22,090
	15	22,395	31,355	40,600	21,920	40,600	22,090
	25	37,330	47,240	42,155	21,920	47,865	22,090

1 Tabulated values are for estimation purposes only and should not be used for design (please use our free TruSpec anchorage design software at [www.itwredhead.com](http://www.itwredhead.com))

2 Tabulated values represent strength design per ACI 318 for a single anchor in adequate concrete thickness, not near an edge nor adjacent anchorage, and not for sustained loading.

3 Bond strengths used in calculations are for dry, cracked concrete with periodic inspection

4 Bond strengths used in calculations are for Temperature Range A (maximum long term temperature of 110F, maximum short term temperature of 142F).

# STRENGTH DESIGN TABLE

## A7+

The Most Versatile Quick-Cure

Rebar Tension (lbf) and Shear (lbf) Loads  
in Uncracked Concrete<sup>1,2,3,4</sup> ASTM A615 Grade 60

Rebar	Anchor Diameter (in.)	Embedment Depth (in.)	Tension (lbf)					Shear (lbf)
			2500 psi	3000 psi	4000 psi	5000 psi	6000 - 8000 psi	2500 - 8000 psi
#3	3/8	3-3/8	3,660	3,660	3,660	3,660	3,660	3,560
		4-1/2	4,880	4,880	4,880	4,880	4,880	3,560
		7-1/2	4,835	6,435	6,435	6,435	6,435	3,560
#4	1/2	4-1/2	7,445	7,520	7,520	7,520	7,520	6,480
		6	10,030	10,030	10,030	10,030	10,030	6,480
		10	11,700	11,700	11,700	11,700	11,700	6,480
#5	5/8	5-5/8	10,405	11,395	11,540	11,540	11,540	10,040
		7-1/2	15,385	15,385	15,385	15,385	15,385	10,040
		12-1/2	18,135	18,135	18,135	18,135	18,135	10,040
#6	3/4	6-3/4	13,675	14,870	14,870	14,870	14,870	14,255
		9	19,825	19,825	19,825	19,825	19,825	14,255
		15	25,740	25,740	25,740	25,740	25,740	14,255
#7	7/8	7-7/8	17,235	18,880	19,465	19,465	19,465	19,440
		10-1/2	25,955	25,955	25,955	25,955	25,955	19,440
		17-1/2	35,100	35,100	35,100	35,100	35,100	19,440
#8	1	9	21,060	23,070	25,110	25,110	25,110	25,595
		12	32,420	33,485	33,485	33,485	33,485	25,595
		20	46,215	46,215	46,215	46,215	46,215	25,595
#9	1-1/8	10-1/8	25,130	27,525	31,195	31,195	31,195	32,400
		13-1/2	38,690	41,590	41,590	41,590	41,590	32,400
		22-1/2	58,500	58,500	58,500	58,500	58,500	32,400
#10	1-1/4	11-1/4	29,430	32,240	37,225	41,620	44,505	41,145
		15	45,310	49,635	57,315	59,345	59,345	41,145
		25	74,295	74,295	74,295	74,295	74,295	41,145

1 Tabulated values are for estimation purposes only and should not be used for design (please use our free TruSpec anchorage design software at [www.itwredhead.com](http://www.itwredhead.com))

2 Tabulated values represent strength design per ACI 318 for a single anchor in adequate concrete thickness, not near an edge nor adjacent anchorage, and not for sustained loading.

3 Bond strengths used in calculations are for dry, uncracked concrete with periodic inspection

4 Bond strengths used in calculations are for Temperature Range A (maximum long term temperature of 110F, maximum short term temperature of 142F).



# STRENGTH DESIGN TABLE

## A7+

The Most Versatile Quick-Cure

Rebar Tension (lbf) and Shear (lbf) Loads  
in Cracked Concrete<sup>1,2,3,4</sup> ASTM A615 Grade 60

Rebar	Anchor Diameter (in.)	Embedment Depth (in.)	Tension (lbf) 2500 - 8000 psi concrete	Shear (lbf) 2500 - 8000 psi concrete
#3	3/8	3-3/8	1,650	2,310
		4-1/2	2,200	3,080
		7-1/2	3,665	3,560
#4	1/2	4-1/2	2,935	4,105
		6	3,910	5,475
		10	6,520	6,480
#5	5/8	5-5/8	4,585	6,420
		7-1/2	6,115	8,560
		12-1/2	10,190	10,040
#6	3/4	6-3/4	5,115	7,160
		9	6,820	9,550
		15	11,370	14,255
#7	7/8	7-7/8	6,965	9,750
		10-1/2	9,285	13,000
		17-1/2	15,475	19,440
#8	1	9	9,095	12,735
		12	12,125	16,980
		20	20,215	25,595
#9	1-1/8	10-1/8	11,510	16,115
		13-1/2	15,350	21,490
		22-1/2	25,585	32,400
#10	1-1/4	11-1/4	16,795	23,515
		15	22,395	31,355
		25	37,330	41,145

1 Tabulated values are for estimation purposes only and should not be used for design (please use our free TruSpec anchorage design software at [www.itwredhead.com](http://www.itwredhead.com))

2 Tabulated values represent strength design per ACI 318 for a single anchor in adequate concrete thickness, not near an edge nor adjacent anchorage, and not for sustained loading.

3 Bond strengths used in calculations are for dry, cracked concrete with periodic inspection

4 Bond strengths used in calculations are for Temperature Range A (maximum long term temperature of 110F, maximum short term temperature of 142F).

## MASONRY DESIGN TABLE

**A7+**  
The Most Versatile Quick-Cure

**Grout-filled Concrete Block: Threaded Rod Allowable Tension and Shear Load Based on Steel Design Information for U.S. Customary Unit<sup>1,2,3</sup>**

Anchor Diameter (in.)	Tension (lb)			Shear (lb)		
	ASTM A307 F <sub>u</sub> = 60 ksi	ASTM A193 Grade B7 F <sub>u</sub> = 125 ksi	ASTM F593 SS 304 F <sub>u</sub> = 100 ksi	ASTM A307 F <sub>u</sub> = 60 ksi	ASTM A193 Grade B7 F <sub>u</sub> = 125 ksi	ASTM F593 SS 304 F <sub>u</sub> = 100 ksi
3/8	2,185	4,555	3,645	1,125	2,345	1,875
1/2	3,885	8,100	6,480	2,000	4,170	3,335
5/8	6,075	12,655	10,125	3,130	6,520	5,215
3/4	8,750	18,225	12,390	4,505	9,390	6,385

For SI: 1 inch = 25.4mm, 1 lbf = 4.45N, 1ft-lbf = 1.356 N-M, 1 psi = 0.006895 MPa

- 1 Allowable load used in the design must be the lesser of bond values and tabulated steel element values.
- 2 Allowable tension and shear loads for threaded rods to resist short term loads, such as wind or seismic, must be calculated in accordance with Section 4.1 of ICC ESR 3951as applicable.
- 3 Allowable steel loads are based on allowable tension and shear stresses equal to 0.33X Fu and 0.17xFu, respectively.

## MASONRY DESIGN TABLE

**A7+**  
The Most Versatile Quick-Cure

**Grout-filled Concrete Block: Threaded Rod Allowable Tension Loads with Reduction Factors<sup>1,2,3,4,7,9,10,12</sup>**

Anchor Diameter (in.)	Minimum Embedment (inches)	Load at scr and c <sub>cr</sub> (lb)	Spacing <sup>5</sup>			Edge Distance <sup>6</sup>		
			Critical s <sub>cr</sub> (inches)	Minimum s <sub>min</sub> (inches)	Load reduction factor for s <sub>min</sub> <sup>8</sup>	Critical c <sub>cr</sub> (inches)	Minimum c <sub>min</sub> (inches)	Load reduction factor for c <sub>min</sub> <sup>8</sup>
3/8	3-3/8	1,125	13.5	4	1.00	12	4	1.00
1/2	4-1/2	1,695	18	4	0.60	20	4	0.90
5/8	5-5/8	2,015	22.5	4	0.60	20	4	0.90
3/4	6-3/4	3,145	27	4	0.60	20	4	0.63

## MASONRY DESIGN TABLE

**A7+**  
The Most Versatile Quick-Cure

**Grout-filled Concrete Block: Threaded Rod Allowable Shear Loads with Reduction Factors<sup>1,2,3,4,7,9,10,12</sup>**

Anchor Diameter (in.)	Minimum Embedment (in.)	Load at s <sub>cr</sub> and c <sub>cr</sub> (lb.)	Spacing <sup>5</sup>			Edge Distance <sup>6</sup>		
			Critical s <sub>cr</sub> (in.)	Minimum s <sub>min</sub> (in.)	Load reduction factor for s <sub>min</sub> <sup>8</sup>	Critical c <sub>cr</sub> (in.)	Minimum c <sub>min</sub> (in.)	Load reduction factor for c <sub>min</sub> <sup>8</sup>
3/8	3-3/8	750	13.5	4	0.50	12	4	0.95
1/2	4-1/2	1,520	18	4	0.50	20	4	0.44
5/8	5-5/8	2,285	22.5	4	0.50	12	4	0.26
3/4	6-3/4	2,345	27	4	0.50	20	4	0.26

For SI: 1 inch = 25.4mm, 1 lbf = 0.0044 kN, 1 ksi = 6.894 MPa. (Refer to Table 4 for footnotes)

1. All values are for anchors installed in fully grouted concrete masonry with minimum masonry strength of 1500 psi (10.3 MPa). Concrete masonry units must be light-, medium, or normal-weight conforming to ASTM C 90. Allowable loads have been calculated using a safety factor of 5.0.
2. Anchors may be installed in any location in the face of the masonry wall (cell, web, bed joint).
3. A maximum of two anchors may be installed in a single masonry cell in accordance with the spacing and edge or end distance requirements. Embedment is measured from the outside surface of the concrete masonry unit to the embedded end of the anchor. See Figure 2 of ICC ESR 3951.
4. The critical spacing distance, s<sub>cr</sub>, is the anchor spacing where full load values in the table may be used. The minimum spacing distance, s<sub>min</sub>, is the minimum anchor spacing for which values are available and installation is permitted. Spacing distance is measured from the centerline to centerline between two anchors.
5. The critical edge or end distance, c<sub>cr</sub>, is the distance where full load values in the table may be used. The minimum edge or end distance, c<sub>min</sub>, is the minimum distance for which values are available and installation is permitted. Edge or end distance is measured from anchor centerline to the closest unrestrained edge.
6. The tabulated values are applicable for anchors in the ends of grout-filled concrete masonry units where minimum edge distances are maintained.
7. Load values for anchors installed less than s<sub>cr</sub> and c<sub>cr</sub> must be multiplied by the appropriate load reduction factor based on actual spacing (s) or edge distance (c). Load factors are multiplicative; both spacing and edge reduction factors must be considered.
8. Linear interpolation of load values between minimum spacing (s<sub>min</sub>) and critical spacing (s<sub>cr</sub>) and between minimum edge or end distance (c<sub>min</sub>) and critical edge or end distance (c<sub>cr</sub>) is permitted.
9. Concrete masonry width (wall thickness) must be equal to or greater than 1.5 times the anchor embedment depth (e.g. 3/8-inch- and 1/2-inch-diameter anchors are permitted in minimum nominally 6-inch-thick concrete masonry). The 5/8- and 3/4-inch-diameter anchors must be installed in minimum nominally 8-inch-thick concrete masonry.
10. Allowable loads must be the lesser of the adjusted masonry or bond values tabulated above and the steel strength values given in Table 2 of ECC ESR 3951.
11. Tabulated allowable bond loads must be adjusted for increased in-service base material temperatures in accordance with Figure 1 of ECC ESR 3951.



Call our toll free number 800-848-5611 or visit our web site for the most current product and technical information at [www.itwredhead.com](http://www.itwredhead.com)



## MASONRY DESIGN TABLE

### A7+

The Most Versatile Quick-Cure

**Grout-filled Concrete Block: Rebar Allowable Tension and Shear Loads<sup>1, 2, 3</sup>**

Rebar Size	Tension (lb) ASTM A615, Grade 60	Shear (lb) ASTM A615, Grade 60
No. 3	3,270	1,685
No. 4	5,940	3,060
No. 5	9,205	4,745
No. 6	13,070	6,730

For SI: 1 inch = 25.4mm, 1 lbf = 4.45N, 1ft-lbf = 1.356 N-M, 1 psi = 0.006895 MPa

- 1 Allowable load used in the design must be the lesser of bond values and tabulated steel element values.
- 2 Allowable tension and shear loads for threaded rods to resist short term loads, such as wind or seismic, must be calculated in accordance with Section 4.1 of ICC ESR 3951 as applicable.
- 3 Allowable steel loads are based on allowable tension and shear stresses equal to 0.33X Fu and 0.17xFu, respectively.

## MASONRY DESIGN TABLE

### A7+

The Most Versatile Quick-Cure

**Grout-filled Concrete Block: Rebar Allowable Tension Loads with Reduction Factors<sup>1, 2, 3, 4, 7, 9, 10, 12</sup>**

Anchor Diameter (in.)	Minimum Embedment (inches)	Load at $s_{cr}$ and $c_{cr}$ (lb.)	Spacing <sup>5</sup>			Edge Distance <sup>6</sup>		
			Critical $s_{cr}$ (in.)	Minimum $s_{min}$ (in.)	Load reduction factor for $s_{min}$ <sup>8</sup>	Critical $c_{cr}$ (in.)	Minimum $c_{min}$ (in.)	Load reduction factor for $c_{min}$ <sup>8</sup>
3/8	3-3/8	1,530	13.5	4	1.00	12	4	1.00
1/2	4-1/2	1,845	18	4	0.60	20	4	0.90
5/8	5-5/8	2,465	22.5	4	0.60	20	4	0.90
3/4	6-3/4	2,380	27	4	0.60	20	4	0.63

## MASONRY DESIGN TABLE

### A7+

The Most Versatile Quick-Cure

**Grout-filled Concrete Block: Rebar Allowable Shear Loads with Reduction Factors<sup>1, 2, 3, 4, 7, 9, 10, 12</sup>**

Anchor Diameter (in.)	Minimum Embedment (in.)	Load at $s_{cr}$ and $c_{cr}$ $\perp$ to edge (lb.)	Spacing <sup>5</sup>			Edge Distance <sup>6</sup>		
			Critical $s_{cr}$ (in.)	Minimum $s_{min}$ (in.)	Load reduction factor for $s_{min}$ <sup>8</sup>	Critical $c_{cr}$ (in.)	Minimum $c_{min}$ (in.)	Load reduction factor for $c_{min}$ <sup>8</sup>
3/8	3-3/8	1,410	13.5	4	0.50	12	4	0.95
1/2	4-1/2	1,680	18	4	0.50	20	4	0.44
5/8	5-5/8	3,245	22.5	4	0.50	12	4	0.26
3/4	6-3/4	4,000	27	4	0.50	20	4	0.26

For SI: 1 inch = 25.4 mm; 1 lbf = 0.0044 kN, 1 ksi = 6.894 MPa.

(The following footnotes apply to both Tables 6 and 7)

- 1 All values are for anchors installed in fully grouted concrete masonry with minimum masonry strength of 1500 psi (10.3 MPa). Concrete masonry units must be light-, medium-, or normal-weight conforming to ASTM C 90. Allowable loads have been calculated using a safety factor of 5.0.
- 2 Anchors may be installed in any location in the face of the masonry wall (cell, web, bed joint).
- 3 A maximum of two anchors may be installed in a single masonry cell in accordance with the spacing and edge or end distance requirements. Embedment is measured from the outside surface of the concrete masonry unit to the embedded end of the anchor. See Figure 2 of ICC ESR 3951.
- 4 The critical spacing distance,  $s_{cr}$ , is the anchor spacing where full load values in the table may be used. The minimum spacing distance,  $s_{min}$ , is the minimum anchor spacing for which values are available and installation is permitted. Spacing distance is measured from the centerline to centerline between two anchors.
- 5 The critical edge or end distance,  $c_{cr}$ , is the distance where full load values in the table may be used. The minimum edge or end distance,  $c_{min}$ , is the minimum distance for which values are available and installation is permitted. Edge or end distance is measured from anchor centerline to the closest unrestrained edge.
- 6 The tabulated values are applicable for anchors in the ends of grout-filled concrete masonry units where minimum edge distances are maintained.
- 7 Load values for anchors installed less than  $s_{cr}$  and  $c_{cr}$  must be multiplied by the appropriate load reduction factor based on actual spacing ( $s$ ) or edge distance ( $c$ ). Load factors are multiplicative; both spacing and edge reduction factors must be considered.
- 8 Linear interpolation of load values between minimum spacing ( $s_{min}$ ) and critical spacing ( $s_{cr}$ ) and between minimum edge or end distance ( $c_{min}$ ) and critical edge or end distance ( $c_{cr}$ ) is permitted.
- 9 Concrete masonry width (wall thickness) must be equal to or greater than 1.5 times the anchor embedment depth (e.g. No. 3 and No. 4 reinforcing bars are permitted in minimum nominally 6-inch-thick concrete masonry). No. 5 and No. 6 reinforcing bars must be installed in minimum nominally 8-inch-thick concrete masonry.
- 10 Allowable loads must be the lesser of the adjusted masonry or bond values tabulated above and the steel strength values given in Table 2 of ICC ESR 3951.
- 12 Tabulated allowable bond loads must be adjusted for increased in-service base material temperatures in accordance with Figure 1 of ICC ESR 3951 as applicable.

# C6+

## For the Most Demanding Jobs



C6P-15

C6P-30



## DESCRIPTION

### Maximum strength epoxy for your most heavy-duty and specialty applications

Red Head C6+ is the highest strength adhesive in our history. Designed for use in the most demanding anchoring applications, the maximum strength of Red Head C6+ is backed by ICC-ES (AC308, AC58) approvals for both concrete and masonry. It is also the only adhesive approved for core-drilled holes in cracked concrete without the use of a roughening tool.

- At least 25% stronger than the old Epcon C6+ formulation for threaded rod in cracked concrete with seismic conditions
- Fastest Cure time in its class, curing in just 2.75 hours at 90°F and in only 2 hours at 110°F!
- ICC-ES listing for cracked concrete and seismic applications (ICC-ES ESR 4046)
- ICC-ES listing for masonry applications (ICC-ES ESR 4109)
- ICC-ES listing for use in core-drill holes, even in cracked concrete
- ICC-ES listing for all wet conditions (including underwater)
- Rebar fire performance report in accordance with EAD (European Assessment Document)
- At least 10 minutes of nozzle life (Even at 110F!)
- Can be used down to 40°F and up to 110°F
- Can be used in oversized and core drilled holes
- Buy American Compliant. Made in USA with U.S. and Global Materials
- Rugged cartridges resist breakage due to rough handling or cold temperatures
- 24-month shelf life
- Store between 50°F and 95°F in a cool, dry place.

## ADVANTAGES

- The industry's first adhesive to be approved for use in core-drilled holes in cracked concrete without the need for a roughening tool
- Install Red Head C6+ and apply the load in the same work shift! (in 70F and above)
- Can be used in wet/damp/underwater applications
- More safe and durable on job sites than sausage packs
- Can use in both concrete and masonry substrates, including hollow and solid base materials

## Cure and Gel Times

BASE MATERIAL (F°/C°)	GEL TIME <sup>2</sup>	FULL CURE TIME
110°/ 43°	10 minutes	2 hours
90°/ 32°	14 minutes	2.75 hours
70°/ 21°	16 minutes	6.5 hours
50°/ 10°	30 minutes	24 hours
40°/ 4.4°	46 minutes	48 hours

1 For concrete temperatures between 40-50°F adhesive must be maintained at a minimum of 50°F during installation.

2 Gel time is max time from the end of mixing to when the insertion of the threaded rod or rebar into the adhesive shall be completed.

## INSTALLATION STEPS for Carbide-Tipped Bits

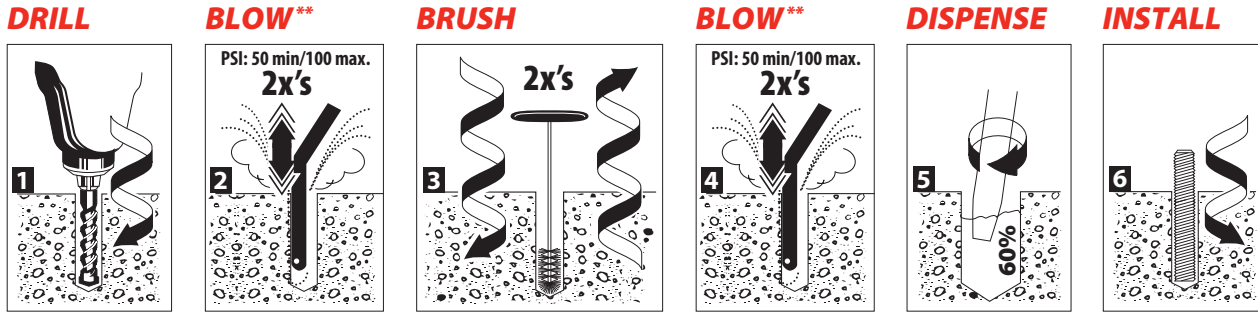

\* Damp, submerged and underwater applications require 4x's air, 4x's brushing and 4x's air

\*\* Dust is shown for diagram purposes only. To help mitigate airborne dust and comply with OSHA requirements, we recommend that you either wet the concrete before blowing out the hole, or use a drill dust extractor with your pneumatic air nozzle. We recommend vacuum assisted dust extractors like Milwaukee part numbers 5261-DE or 5317-DE. Call our technical services at (800) 848-5611 for more information.

## INSTALLATION STEPS for Core-Drilled Holes

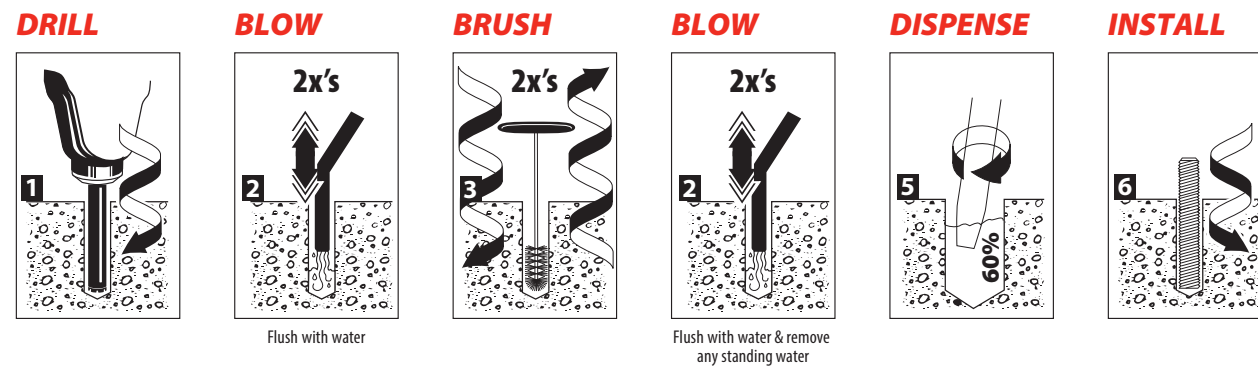

## APPROVALS/LISTINGS

- ICC-ES ESR 4046 (Concrete Report)
- ICC-ES ESR 4109 (Masonry Report)
- 2018, 2015, 2012, 2009, 2006 International Building Code (IBC) Compliant
- Florida Building Code (FBC)
- City of Los Angeles (COLA)
- Department of Transportation (DOT) Listings
- NSF/ANSI 61 Approval for use in Drinking Water System Components
- ASTM C881, Types I, II, IV, and V, Grade 3, Classes B & C
- Rebar fire performance report in accordance with EAD (European Assessment Document)





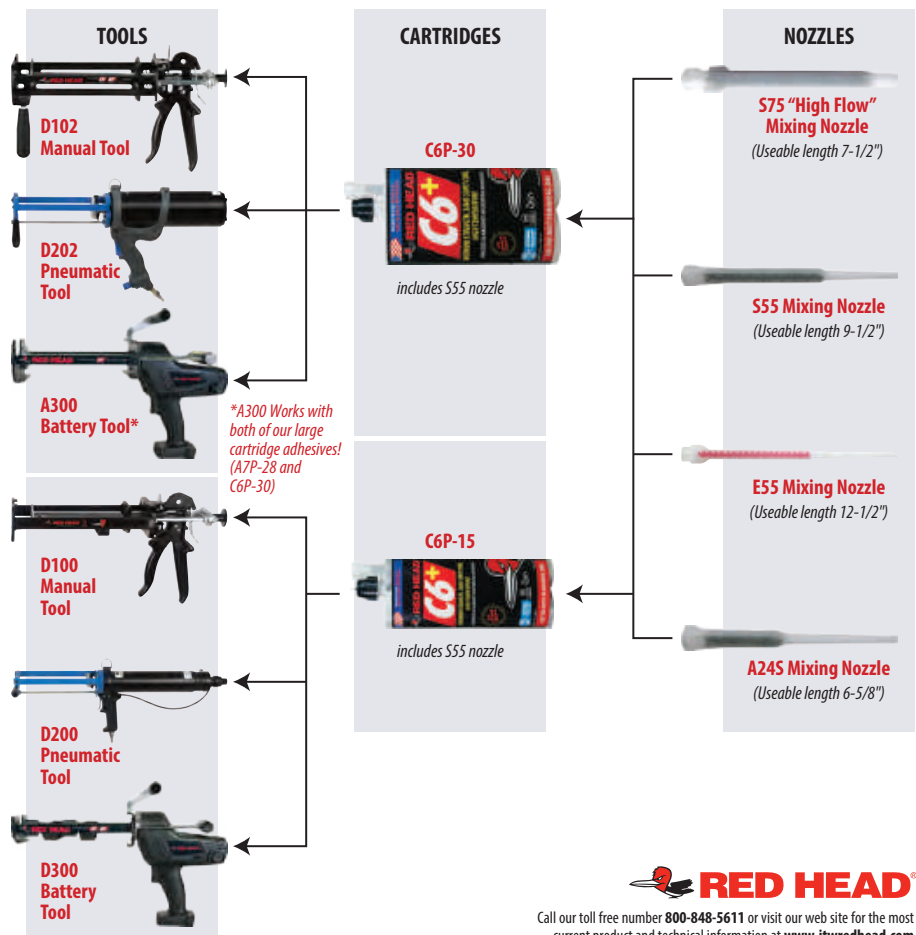

For the most current approvals/listings visit:  
[www.itwredhead.com](http://www.itwredhead.com)

## Selection Guide





## C6P-15 fl. oz. Ordering Information

PART NUMBER	DESCRIPTION	BOX QTY	PART NUMBER	DESCRIPTION	BOX QTY
 C6P-15	15.2 Fluid Ounce Red Head C6+ Cartridge with S55 Nozzle	4	 D200	Ergonomic Pneumatic Dispenser for C6P-15 cartridge.	1
 D100	Heavy-Duty 34:1 thrust ratio hand dispenser for C6P-15 cartridge.	1	 D300	Cordless Battery Dispenser for C6P-15 cartridge. Includes one battery and charger. Works with all Milwaukee® M18™ batteries	1
 S55	Standard Mixing Nozzle, fits holes for 3/8" diameter anchors and larger. 3-1/2" useable length for 3/8" and 1/2" anchors, 9-1/2" useable length for 5/8" anchors and above	24	 S75	High Flow Mixing Nozzle, fits holes for 3/4" diameter anchors and larger. 7-1/2" useable length	24
 E55	Long Mixing Nozzle, fits holes for 3/8" diameter anchors and larger. 5-3/4" inch useable length for 3/8" and 1/2" anchors, 12-1/2" useable length for 5/8" anchors and above	24			

\*See page 55 for nozzle extension tubes and other accessories

### ESTIMATING TABLES

## C6P-15 15.2 Fluid Ounce Cartridge

**Number of Anchoring Installations Per Cartridge\*  
using Threaded Rod or Rebar with C6+ in Solid Concrete**

ANCHOR DIA. in.	# rebar	DRILL HOLE DIA. (in.)	EMBEDMENT DEPTH IN INCHES														
			1	2	3	4	5	6	7	8	9	10	11	12	13	14	15
3/8	#3	7/16	304.5	152.2	101.5	76.1	60.9	50.7	43.5	38.1	33.8	30.4	27.7	25.4	23.4	21.7	20.3
1/2		9/16	184.2	92.1	61.4	46.0	36.8	30.7	26.3	23.0	20.5	18.4	16.7	15.3	14.2	13.2	12.3
	#4	5/8	149.2	74.6	49.7	37.3	29.8	24.9	21.3	18.6	16.6	14.9	13.6	12.4	11.5	10.7	9.9
5/8	#5	3/4	103.6	51.8	34.5	25.9	20.7	17.3	14.8	12.9	11.5	10.4	9.4	8.6	8.0	7.4	6.9
3/4	#6	7/8	76.1	38.1	25.4	19.0	15.2	12.7	10.9	9.5	8.5	7.6	6.9	6.3	5.9	5.4	5.1
7/8	#7	1	58.3	29.1	19.4	14.6	11.7	9.7	8.3	7.3	6.5	5.8	5.3	4.9	4.5	4.2	3.9
1	#8	1-1/8	46.0	23.0	15.3	11.5	9.2	7.7	6.6	5.8	5.1	4.6	4.2	3.8	3.5	3.3	3.1
	#9	1-1/4	37.3	18.6	12.4	9.3	7.5	6.2	5.3	4.7	4.1	3.7	3.4	3.1	2.9	2.7	2.5
1-1/4		1-3/8	30.8	15.4	10.3	7.7	6.2	5.1	4.4	3.9	3.4	3.1	2.8	2.6	2.4	2.2	2.1
	#10	1-1/2	25.9	12.9	8.6	6.5	5.2	4.3	3.7	3.2	2.9	2.6	2.4	2.2	2.0	1.8	1.7
1-1/2"		1-5/8"	22.1	11.0	7.4	5.5	4.4	3.7	3.2	2.8	2.5	2.2	2.0	1.8	1.7	1.6	1.5
	#11	1-3/4	19.0	9.5	6.3	4.8	3.8	3.2	2.7	2.4	2.1	1.9	1.7	1.6	1.5	1.4	1.3







\*The estimated number of anchoring installations per cartridge is based upon calculations of filling the hole 60% full of adhesive per the recommendation in our installation instructions. Hole volumes are calculated using ANSI tolerance carbide tipped drill bits. These estimates do not account for any waste.



Call our toll free number 800-848-5611 or visit our web site for the most current product and technical information at [www.itwredhead.com](http://www.itwredhead.com)



# C6P-30.4 fl. oz. Ordering Information

PART NUMBER	DESCRIPTION	BOX QTY	PART NUMBER	DESCRIPTION	BOX QTY
 C6P-30	30.4 Fluid Ounce Red Head C6+ Cartridge with S55 Nozzle	4	 D202	Pneumatic Dispenser for C6P-30 cartridge	1
 D102	Heavy-Duty 34:1 thrust ratio hand dispenser for C6P-30 cartridge	1	 A300	Cordless Battery Dispenser for A7P-28 and C6P-30 Cartridges. Includes one battery and charger. Works with all Milwaukee® M18™ batteries (Contact Milwaukee® for more information on batteries)	1
 S55	Standard Mixing Nozzle, fits holes for 3/8" diameter anchors and larger. 3-1/2" inch useable length for 3/8" and 1/2" anchors, 9-1/2" useable length for 5/8" anchors and above	24	 S75	High Flow Mixing Nozzle, fits holes for 3/4" diameter anchors and larger. 7-1/2" useable length	24
 E55	Long Mixing Nozzle, fits holes for 3/8" diameter anchors and larger. 5-3/4" inch useable length for 3/8" and 1/2" anchors, 12-1/2" useable length for 5/8" anchors and above	24			

\*See page 55 for nozzle extension tubes and other accessories

## ESTIMATING TABLES

### C6P-30

30.4 Fluid Ounce Cartridge

**Number of Anchoring Installations Per Cartridge\*  
using Threaded Rod or Rebar with C6+ in Solid Concrete**

ANCHOR DIA.		DRILL HOLE DIA. (in.)	EMBEDMENT DEPTH IN INCHES														
in.	# rebar		1	2	3	4	5	6	7	8	9	10	11	12	13	14	15
3/8	#3	7/16	608.9	304.5	203.0	152.2	121.8	101.5	87.0	76.1	67.7	60.9	55.4	50.7	46.8	43.5	40.6
1/2		9/16	368.3	184.2	122.8	92.1	73.7	61.4	52.6	46.0	40.9	36.8	33.5	30.7	28.3	26.3	24.6
	#4	5/8	298.4	149.2	99.5	74.6	59.7	49.7	42.6	37.3	33.2	29.8	27.1	24.9	23.0	21.3	19.9
5/8	#5	3/4	207.2	103.6	69.1	51.8	41.4	34.5	29.6	25.9	23.0	20.7	18.8	17.3	15.9	14.8	13.8
3/4	#6	7/8	152.2	76.1	50.7	38.1	30.4	25.4	21.7	19.0	16.9	15.2	13.8	12.7	11.7	10.9	10.1
7/8	#7	1	116.5	58.3	38.8	29.1	23.3	19.4	16.6	14.6	12.9	11.7	10.6	9.7	9.0	8.3	7.8
1	#8	1-1/8	92.1	46.0	30.7	23.0	18.4	15.3	13.2	11.5	10.2	9.2	8.4	7.7	7.1	6.6	6.1
	#9	1-1/4	74.6	37.3	24.9	18.6	14.9	12.4	10.7	9.3	8.3	7.5	6.8	6.2	5.7	5.3	5.0
1-1/4		1-3/8	61.6	30.8	20.5	15.4	12.3	10.3	8.8	7.7	6.8	6.2	5.6	5.1	4.7	4.4	4.1
	#10	1-1/2	51.8	25.9	17.3	12.9	10.4	8.6	7.4	6.5	5.8	5.2	4.7	4.3	4.0	3.7	3.5
1-1/2		1-5/8	44.1	22.1	14.7	11.0	8.8	7.4	6.3	5.5	4.9	4.4	4.0	3.7	3.4	3.2	2.9
	#11	1-3/4	38.1	19.0	12.7	9.5	7.6	6.3	5.4	4.8	4.2	3.8	3.5	3.2	2.9	2.7	2.5

\*The estimated number of anchoring installations per cartridge is based upon calculations of filling the hole 60% full of adhesive per the recommendation in our installation instructions. Hole volumes are calculated using ANSI tolerance carbide tipped drill bits. These estimates do not account for any waste.

## PERFORMANCE TABLE

# C6+

For the Most Demanding Jobs

**Threaded Rod Ultimate Tension and Shear Loads<sup>1,2,3</sup>  
Installed in Solid Concrete**

THREADED ROD DIA. (in.)	EMBEDMENT IN CONCRETE (in.)	MAX. CLAMPING FORCE AFTER PROPER CURE (ft./lbs.)	ULTIMATE TENSION (lbs.)			ULTIMATE SHEAR (lbs.)
			3,000 PSI CONCRETE	5,000 PSI CONCRETE	7,000 PSI CONCRETE	3,000 PSI CONCRETE & HIGHER
3/8	1-1/2	9	3,160	3,785	4,405	N/A
	3-3/8		11,640	12,315	12,985	5,200
1/2	2	16	6,075	7,015	7,950	N/A
	4-1/2		20,005	23,305	26,605	11,420
5/8	2-1/2	47	8,570	9,995	11,420	N/A
	5-5/8		24,905	29,015	33,125	18,300
3/4	3	70	12,030	13,570	15,105	N/A
	6-3/4		36,645	42,695	48,740	25,720
7/8	3-1/2	90	15,005	17,335	19,660	N/A
	7-7/8		55,575	70,338	85,100	32,120
1	4	110	17,735	20,390	23,045	N/A
	9		62,250	73,850	85,450	38,520
1-1/4	5	370	34,695	36,935	39,170	N/A
	11-1/4		77,815	90,655	103,495	65,080
1-1/2	13	450	101,085	117,765	134,445	N/A

1 Allowable working loads for the single installations under static loading should not exceed 25% capacity of the Ultimate Load. To calculate the Allowable Load of the anchor rod, divide the Ultimate Load by 4.

2 Performance values are based on the use of high strength threaded rod (ASTM A193 Gr. B7). The use of lower strength rods will result in lower ultimate tension and shear loads.

3 Linear interpolation may be used for intermediate spacing and edge distances.

## PERFORMANCE TABLE

# C6+

For the Most Demanding Jobs

**Threaded Rod Allowable Tension Loads<sup>1</sup>  
Installed in Solid Concrete**

THREADED ROD DIA. in.	EMBEDMENT IN CONCRETE in.	ALLOWABLE TENSION LOAD BASED ON CONCRETE STRENGTH (lbs.)			ALLOWABLE TENSION LOAD BASED ON STEEL STRENGTH (lbs.)		
		3,000 psi concrete	5,000 psi concrete	7,000 psi concrete	ASTM A307	ASTM A193 GRADE B7	ASTM F593 AISI 304 SS
3/8	1-1/2	790	945	1,100	2,080	4,340	3,995
	3-3/8	2,910	3,080	3,245	2,080	4,340	3,995
1/2	2	1,520	1,755	1,990	3,730	7,780	7,155
	4-1/2	5,000	5,825	6,650	3,730	7,780	7,155
5/8	2-1/2	2,145	2,500	2,855	5,870	12,230	11,250
	5-5/8	6,225	7,255	8,280	5,870	12,230	11,250
3/4	3	3,010	3,395	3,775	8,490	17,690	14,860
	6-3/4	9,160	10,675	12,185	8,490	17,690	14,860
7/8	3-1/2	3,750	4,335	4,915	11,600	25,510	20,835
	7-7/8	13,895	17,585	21,275	11,600	25,510	20,835
1	4	4,435	5,100	5,760	15,180	31,620	26,560
	9	15,565	18,465	21,365	15,180	31,620	26,560
1-1/4	5	8,675	9,235	9,795	23,800	49,580	34,670
	11-1/4	19,455	22,665	25,875	23,800	49,580	34,670
1-1/2	13	25,270	29,440	33,610	33,720	70,250	47,770

1 Use lower value of either bond or steel strength for allowable tension load.



Call our toll free number 800-848-5611 or visit our web site for the most current product and technical information at [www.itwredhead.com](http://www.itwredhead.com)



## PERFORMANCE TABLE

# C6+

For the Most Demanding Jobs

**Threaded Rod Allowable Shear Loads<sup>1</sup>  
Installed in Solid Concrete**

THREADED ROD DIA. (in.)	EMBEDMENT IN CONCRETE (in.)	ALLOWABLE SHEAR LOAD BASED ON CONCRETE STRENGTH (lbs.)		ALLOWABLE SHEAR LOAD BASED ON STEEL STRENGTH (lbs.)		
		3,000 psi concrete & higher		ASTM A307	ASTM A193 GRADE B7	ASTM F593 AISI 304 SS
3/8	1-1/2	N/A		1,040	2,170	1,995
	3-3/8	1,300		1,040	2,170	1,995
1/2	2	N/A		1,870	3,895	3,585
	4-1/2	2,855		1,870	3,895	3,585
5/8	2-1/2	N/A		2,940	6,125	5,635
	5-5/8	4,575		2,940	6,125	5,635
3/4	3	N/A		4,250	8,855	7,440
	6-3/4	6,430		4,250	8,855	7,440
7/8	3-1/2	N/A		5,800	12,760	10,730
	7-7/8	8,030		5,800	12,760	10,730
1	4	N/A		7,590	15,810	13,285
	9	9,630		7,590	15,810	13,285
1-1/4	5	N/A		11,900	24,790	18,840
	11-1/4	16,270		11,900	24,790	18,840

<sup>1</sup> Use lower value of either concrete or steel strength for allowable shear load.

## PERFORMANCE TABLE

# C6+

For the Most Demanding Jobs

**Rebar Ultimate Tension Loads<sup>1,2,3</sup>  
Installed in Solid Concrete**

REINFORCING BAR	EMBEDMENT IN CONCRETE (in.)	ULTIMATE TENSION (lbs.)			ULTIMATE YIELD STRENGTH GRADE 60 REBAR (lbs.)	ULTIMATE TENSILE STRENGTH GRADE 60 REBAR (lbs.)
		3,000 psi concrete	5,000 psi concrete	7,000 psi concrete		
#3	1-1/2	3,160	3,785	4,405	6,600	9,900
	3-3/8	11,640	12,315	12,985		
#4	2	6,075	7,015	7,950	12,000	18,000
	4-1/2	20,005	23,305	26,605		
#5	2-1/2	8,570	9,995	11,420	18,600	27,900
	5-5/8	24,905	29,015	33,125		
#6	3	12,030	13,570	15,105	26,400	39,600
	6-3/4	36,645	42,695	48,740		
#7	3-1/2	15,005	17,335	19,660	36,000	54,000
	7-7/8	55,575	70,338	85,100		
#8	4	17,735	20,390	23,045	47,400	71,100
	9	62,250	73,850	85,450		
#10	5	34,695	36,935	39,170	79,200	114,300
	11-1/4	77,815	90,655	103,495		
#11	13	101,085	117,764	134,443	93,600	140,400

<sup>1</sup> Allowable working loads for the single installation under static loading should not exceed 25% capacity of the Ultimate Load. To calculate the Allowable Load of the anchor, divide the ultimate load by 4.

<sup>2</sup> Performance values are based on the use of ASTM A615 Grade 60 reinforcing bar. The use of lower strength rebar will result in lower ultimate tension loads.

<sup>3</sup> SHEAR DATA: Provided the distance from the rebar to the edge of the concrete member exceeds 1.25 times the embedment depth of the rebar, calculate the ultimate shear load for the rebar anchorage as 60% of the ultimate tensile strength of the rebar.

## PERFORMANCE REFERENCE TABLE

# C6+

For the Most Demanding Jobs

**Threaded Rod and Rebar Installation in Solid Concrete  
Edge/Spacing Distance Load Factor Summary<sup>1,2</sup>**

LOAD FACTOR	DISTANCE FROM EDGE OF CONCRETE	LOAD FACTOR	DISTANCE FROM ANOTHER ANCHOR
<b>Critical Edge Distance—Tension</b>		<b>Critical Spacing—Tension</b>	
100% Tension Load	→ 1.25 x Anchor Embedment (or greater)	100% Tension Load	→ 1.50 x Anchor Embedment (or greater)
<b>Minimum Edge Distance—Tension</b>		<b>Minimum Spacing—Tension</b>	
70% Tension Load	→ 0.50 x Anchor Embedment	75% Tension Load	→ 0.75 x Anchor Embedment
<b>Critical Edge Distance—Shear</b>		<b>Critical Spacing—Shear</b>	
100% Shear Load	→ 1.25 x Anchor Embedment (or greater)	100% Shear Load	→ 1.50 x Anchor Embedment (or greater)
<b>Minimum Edge Distance—Shear</b>		<b>Minimum Spacing—Shear</b>	
30% Shear Load	→ 0.30 x Anchor Embedment	30% Shear Load	→ 0.50 x Anchor Embedment

<sup>1</sup> Use linear interpolation for load factors at edge distances or spacing distances between critical and minimum.

<sup>2</sup> Anchors are affected by multiple combination of spacing and/or edge distance loading and direction of the loading. Use the product of tension and shear loading factors in design.

## STRENGTH DESIGN TABLE

# C6+

For the Most Demanding Jobs

**Threaded Rod Tension (lbf) and Shear (lbf) Loads  
in Uncracked Concrete<sup>1,2,3,4</sup> ASTM A193 B7**

ANCHOR DIAMETER (in.)	EMBEDMENT DEPTH (in.)	TENSION (lbf)						SHEAR (lbf)
		2500 psi	3000 psi	4000 psi	5000 psi	6000 psi	7000-8000 psi	2500-8000 psi
3/8	3-3/8	4,835	5,295	6,115	6,380	6,380	6,380	3,775
	4-1/2	7,265	7,265	7,265	7,265	7,265	7,265	3,775
	7-1/2	7,265	7,265	7,265	7,265	7,265	7,265	3,775
1/2	4-1/2	7,445	8,155	9,415	10,530	10,980	10,980	6,915
	6	11,460	12,555	13,305	13,305	13,305	13,305	6,915
	10	13,305	13,305	13,305	13,305	13,305	13,305	6,915
5/8	5-5/8	10,405	11,395	13,160	14,715	16,120	16,615	11,015
	7-1/2	16,020	17,550	20,265	21,185	21,185	21,185	11,015
	12-1/2	21,185	21,185	21,185	21,185	21,185	21,185	11,015
3/4	6-3/4	13,675	14,980	17,300	19,345	19,590	19,590	16,305
	9	21,060	23,070	26,125	26,125	26,125	26,125	16,305
	15	31,355	31,355	31,355	31,355	31,355	31,355	16,305
7/8	7-7/8	17,235	18,880	21,800	24,375	25,715	25,715	22,505
	10-1/2	26,535	29,070	33,565	34,285	34,285	34,285	22,505
	17-1/2	43,280	43,280	43,280	43,280	43,280	43,280	22,505
1	9	21,060	23,070	26,635	29,780	32,420	32,420	29,525
	12	32,420	35,515	41,010	43,230	43,230	43,230	29,525
	20	56,780	56,780	56,780	56,780	56,780	56,780	29,525
1-1/4	11-1/4	29,430	32,240	37,225	41,620	45,595	46,895	47,240
	15	45,310	49,635	57,315	62,525	62,525	62,525	47,240
	25	90,855	90,855	90,855	90,855	90,855	90,855	47,240

- 1 Tabulated values are for estimation purposes only and should not be used for design (please use our free TruSpec anchorage design software at [www.itwredhead.com](http://www.itwredhead.com))
- 2 Tabulated values represent strength design per ACI 318 for a single anchor in adequate concrete thickness, not near an edge nor adjacent anchorage, and not for sustained loading.
- 3 Bond strengths are for dry, uncracked concrete with periodic inspection
- 4 Bond strengths are for Temperature Range A (maximum long term temperature of 110F, maximum short term temperature of 142F).

## STRENGTH DESIGN TABLE

# C6+

For the Most Demanding Jobs

**Threaded Rod Tension (lbf) and Shear (lbf) Loads  
in 4,000 psi Uncracked Concrete<sup>1,2,3,4</sup>**

ANCHOR DIAMETER (in.)	EMBEDMENT DEPTH (in.)	ASTM A193 B7 THREAD ROD		CARBON STEEL A36		STAINLESS STEEL F593	
		TENSION (lbf)	SHEAR (lbf)	TENSION (lbf)	SHEAR (lbf)	TENSION (lbf)	SHEAR (lbf)
3/8	3-3/8	6,115	3,775	3,375	1,755	4,785	2,280
	4-1/2	7,265	3,775	3,375	1,755	4,785	2,280
	7-1/2	7,265	3,775	3,375	1,755	4,785	2,280
1/2	4-1/2	9,415	6,915	6,170	3,210	8,760	4,040
	6	13,305	6,915	6,170	3,210	8,760	4,040
	10	13,305	6,915	6,170	3,210	8,760	4,040
5/8	5-5/8	13,160	11,015	9,830	5,115	13,160	6,440
	7-1/2	20,265	11,015	9,830	5,115	13,955	6,440
	12-1/2	21,185	11,015	9,830	5,115	13,955	6,440
3/4	6-3/4	17,300	16,305	14,550	7,565	16,500	7,610
	9	26,125	16,305	14,550	7,565	16,500	7,610
	15	31,355	16,305	14,550	7,565	16,500	7,610
7/8	7-7/8	21,800	22,505	20,085	10,445	21,800	10,530
	10-1/2	33,565	22,505	20,085	10,445	22,820	10,530
	17-1/2	43,280	22,505	20,085	10,445	22,820	10,530
1	9	26,635	29,525	26,345	13,700	26,635	13,815
	12	41,010	29,525	26,345	13,700	29,935	13,815
	20	56,780	29,525	26,345	13,700	29,935	13,815
1-1/4	11-1/4	37,225	47,240	37,225	21,920	37,225	22,090
	15	57,315	47,240	42,155	21,920	47,865	22,090
	25	90,855	47,240	42,155	21,920	47,865	22,090

- 1 Tabulated values are for estimation purposes only and should not be used for design (please use our free TruSpec anchorage design software at [www.itwredhead.com](http://www.itwredhead.com))
- 2 Tabulated values represent strength design per ACI 318 for a single anchor in adequate concrete thickness, not near an edge nor adjacent anchorage, and not for sustained loading.
- 3 Bond strengths are for dry, uncracked concrete with periodic inspection
- 4 Bond strengths are for Temperature Range A (maximum long term temperature of 110F, maximum short term temperature of 142F).



Call our toll free number 800-848-5611 or visit our web site for the most current product and technical information at [www.itwredhead.com](http://www.itwredhead.com)





## STRENGTH DESIGN TABLE

# C6+

For the Most Demanding Jobs

**Threaded Rod Tension (lbf) and Shear (lbf) Loads  
in Cracked Concrete<sup>1,2,3,4</sup> ASTM A193 B7**

ANCHOR DIAMETER (in.)	EMBEDMENT DEPTH (in.)	TENSION (lbf)						SHEAR (lbf)
		2500 psi	3000 psi	4000 psi	5000 psi	6000 psi	7000-8000 psi	2500-8000 psi
3/8	3-3/8	2,905	2,905	2,905	2,905	2,905	2,905	3,775
	4-1/2	3,875	3,875	3,875	3,875	3,875	3,875	3,775
	7-1/2	6,460	6,460	6,460	6,460	6,460	6,460	3,775
1/2	4-1/2	5,165	5,165	5,165	5,165	5,165	5,165	6,915
	6	6,890	6,890	6,890	6,890	6,890	6,890	6,915
	10	11,485	11,485	11,485	11,485	11,485	11,485	6,915
5/8	5-5/8	7,370	8,070	8,075	8,075	8,075	8,075	11,015
	7-1/2	10,765	10,765	10,765	10,765	10,765	10,765	11,015
	12-1/2	17,945	17,945	17,945	17,945	17,945	17,945	11,015
3/4	6-3/4	9,685	10,610	10,975	10,975	10,975	10,975	15,365
	9	14,635	14,635	14,635	14,635	14,635	14,635	16,305
	15	24,395	24,395	24,395	24,395	24,395	24,395	16,305
7/8	7-7/8	12,210	13,375	14,940	14,940	14,940	14,940	20,915
	10-1/2	18,795	19,920	19,920	19,920	19,920	19,920	22,505
	17-1/2	33,200	33,200	33,200	33,200	33,200	33,200	22,505
1	9	14,915	16,340	18,865	19,515	19,515	19,515	27,320
	12	22,965	25,155	26,020	26,020	26,020	26,020	29,525
	20	43,365	43,365	43,365	43,365	43,365	43,365	29,525
1-1/4	11-1/4	20,845	22,835	26,370	29,480	32,295	33,285	46,600
	15	32,095	35,160	40,600	44,380	44,380	44,380	47,240
	25	69,060	73,970	73,970	73,970	73,970	73,970	47,240

1 Tabulated values are for estimation purposes only and should not be used for design (please use our free TruSpec anchorage design software at [www.itwredhead.com](http://www.itwredhead.com))

2 Tabulated values represent strength design per ACI 318 for a single anchor in adequate concrete thickness, not near an edge nor adjacent anchorage, and not for sustained loading.

3 Bond strengths are for dry, cracked concrete with periodic inspection

4 Bond strengths are for Temperature Range A (maximum long term temperature of 110F, maximum short term temperature of 142F).

## STRENGTH DESIGN TABLE

# C6+

For the Most Demanding Jobs

**Threaded Rod Tension (lbf) and Shear (lbf) Loads  
in 4,000 psi Cracked Concrete<sup>1,2,3,4</sup>**

ANCHOR DIAMETER (in.)	EMBEDMENT DEPTH (in.)	ASTM A193 B7 THREAD ROD		CARBON STEEL A36		STAINLESS STEEL F593	
		TENSION (lbf)	SHEAR (lbf)	TENSION (lbf)	SHEAR (lbf)	TENSION (lbf)	SHEAR (lbf)
3/8	3-3/8	2,905	3,775	3,375	1,755	4,785	2,280
	4-1/2	3,875	3,775	3,375	1,755	4,785	2,280
	7-1/2	6,460	3,775	3,375	1,755	4,785	2,280
1/2	4-1/2	5,165	6,915	6,170	3,210	8,760	4,040
	6	6,890	6,915	6,170	3,210	8,760	4,040
	10	11,485	6,915	6,170	3,210	8,760	4,040
5/8	5-5/8	8,075	11,015	9,830	5,115	13,160	6,440
	7-1/2	10,765	11,015	9,830	5,115	13,955	6,440
	12-1/2	17,945	11,015	9,830	5,115	13,955	6,440
3/4	6-3/4	10,975	15,365	14,550	7,565	16,500	7,610
	9	14,635	16,305	14,550	7,565	16,500	7,610
	15	24,395	16,305	14,550	7,565	16,500	7,610
7/8	7-7/8	14,940	20,915	20,085	10,445	21,800	10,530
	10-1/2	19,920	22,505	20,085	10,445	22,820	10,530
	17-1/2	33,200	22,505	20,085	10,445	22,820	10,530
1	9	19,515	27,320	26,345	13,700	26,635	13,815
	12	26,020	29,525	26,345	13,700	29,935	13,815
	20	43,365	29,525	26,345	13,700	29,935	13,815
1-1/4	11-1/4	33,285	46,600	37,225	21,920	37,225	22,090
	15	44,380	47,240	42,155	21,920	47,865	22,090
	25	73,970	47,240	42,155	21,920	47,865	22,090

1 Tabulated values are for estimation purposes only and should not be used for design (please use our free TruSpec anchorage design software at [www.itwredhead.com](http://www.itwredhead.com))

2 Tabulated values represent strength design per ACI 318 for a single anchor in adequate concrete thickness, not near an edge nor adjacent anchorage, and not for sustained loading.

3 Bond strengths are for dry, cracked concrete with periodic inspection

4 Bond strengths are for Temperature Range A (maximum long term temperature of 110F, maximum short term temperature of 142F).

## STRENGTH DESIGN TABLE

# C6+

For the Most Demanding Jobs

**Rebar Tension (lbf) and Shear (lbf) Loads  
in Uncracked Concrete<sup>1,2,3,4</sup> ASTM A615 Grade 60**

ANCHOR DIAMETER # Rebar	EMBEDMENT DEPTH (in.)	TENSION (lbf)						SHEAR (lbf)
		2500 psi	3000 psi	4000 psi	5000 psi	6000 psi	7000-8000 psi	2500-8000 psi
#3	3-3/8	4,835	5,295	6,110	6,110	6,110	6,110	3,560
	4-1/2	6,435	6,435	6,435	6,435	6,435	6,435	3,560
	7-1/2	4,835	6,435	6,435	6,435	6,435	6,435	3,560
#4	4-1/2	7,445	8,155	9,415	10,450	10,450	10,450	6,480
	6	11,460	11,700	11,700	11,700	11,700	11,700	6,480
	10	11,700	11,700	11,700	11,700	11,700	11,700	6,480
#5	5-5/8	10,405	11,395	13,160	14,715	15,650	15,650	10,040
	7-1/2	16,020	17,550	18,135	18,135	18,135	18,135	10,040
	12-1/2	18,135	18,135	18,135	18,135	18,135	18,135	10,040
#6	6-3/4	13,675	14,980	17,300	18,235	18,235	18,235	14,255
	9	21,060	23,070	24,315	24,315	24,315	24,315	14,255
	15	25,740	25,740	25,740	25,740	25,740	25,740	14,255
#7	7-7/8	17,235	18,880	21,800	23,690	23,690	23,690	19,440
	10-1/2	26,535	29,070	31,590	31,590	31,590	31,590	19,440
	17-1/2	35,100	35,100	35,100	35,100	35,100	35,100	19,440
#8	9	21,060	23,070	26,635	29,465	29,465	29,465	25,595
	12	32,420	35,515	39,290	39,290	39,290	39,290	25,595
	20	46,215	46,215	46,215	46,215	46,215	46,215	25,595
#9	10-1/8	25,130	27,525	31,785	35,525	35,525	35,525	32,400
	13-1/2	38,690	42,380	47,365	47,365	47,365	47,365	32,400
	22-1/2	58,500	58,500	58,500	58,500	58,500	58,500	32,400
#10	11-1/4	29,430	32,240	37,225	41,620	42,210	42,210	41,145
	15	45,310	49,635	56,285	56,285	56,285	56,285	41,145
	25	74,295	74,295	74,295	74,295	74,295	74,295	41,145

- 1 Tabulated values are for estimation purposes only and should not be used for design (please use our free TruSpec anchorage design software at [www.itwredhead.com](http://www.itwredhead.com))
- 2 Tabulated values represent strength design per ACI 318 for a single anchor in adequate concrete thickness, not near an edge nor adjacent anchorage, and not for sustained loading.
- 3 Bond strengths are for dry, uncracked concrete with periodic inspection
- 4 Bond strengths are for Temperature Range A (maximum long term temperature of 110F, maximum short term temperature of 142F).

## STRENGTH DESIGN TABLE

# C6+

For the Most Demanding Jobs

**Rebar Tension (lbf) and Shear (lbf) Loads  
in Cracked Concrete<sup>1,2,3,4</sup> ASTM A615 Grade 60**

ANCHOR DIAMETER # Rebar	EMBEDMENT DEPTH (in.)	TENSION (lbf)						SHEAR (lbf)
		2500 psi	3000 psi	4000 psi	5000 psi	6000 psi	7000-8000 psi	2500-8000 psi
#3	3-3/8	2,825	2,905	2,905	2,905	2,905	3,560	3,560
	4-1/2	3,875	3,875	3,875	3,875	3,875	3,560	3,560
	7-1/2	6,435	6,435	6,435	6,435	6,435	3,560	3,560
#4	4-1/2	5,165	5,165	5,165	5,165	5,165	6,480	6,480
	6	6,890	6,890	6,890	6,890	6,890	6,480	6,480
	10	11,485	11,485	11,485	11,485	11,485	6,480	6,480
#5	5-5/8	7,370	7,965	7,965	7,965	7,965	10,040	10,040
	7-1/2	10,620	10,620	10,620	10,620	10,620	10,040	10,040
	12-1/2	17,705	17,705	17,705	17,705	17,705	10,040	10,040
#6	6-3/4	9,685	10,405	10,405	10,405	10,405	14,255	14,255
	9	13,875	13,875	13,875	13,875	13,875	14,255	14,255
	15	23,130	23,130	23,130	23,130	23,130	14,255	14,255
#7	7-7/8	12,210	13,375	13,570	13,570	13,570	19,000	19,440
	10-1/2	18,095	18,095	18,095	18,095	18,095	19,440	19,440
	17-1/2	30,160	30,160	30,160	30,160	30,160	19,440	19,440
#8	9	14,915	16,340	16,950	16,950	16,950	23,730	25,595
	12	22,600	22,600	22,600	22,600	22,600	25,595	25,595
	20	37,665	37,665	37,665	37,665	37,665	25,595	25,595
#9	10-1/8	17,800	19,495	20,465	20,465	20,465	28,655	32,400
	13-1/2	27,290	27,290	27,290	27,290	27,290	32,400	32,400
	22-1/2	45,485	45,485	45,485	45,485	45,485	32,400	32,400
#10	11-1/4	20,845	22,835	26,370	26,660	26,660	37,325	41,145
	15	32,095	35,160	35,545	35,545	35,545	41,145	41,145
	25	59,245	59,245	59,245	59,245	59,245	41,145	41,145

- 1 Tabulated values are for estimation purposes only and should not be used for design (please use our free TruSpec anchorage design software at [www.itwredhead.com](http://www.itwredhead.com))
- 2 Tabulated values represent strength design per ACI 318 for a single anchor in adequate concrete thickness, not near an edge nor adjacent anchorage, and not for sustained loading.
- 3 Bond strengths are for dry, cracked concrete with periodic inspection
- 4 Bond strengths are for Temperature Range A (maximum long term temperature of 110F, maximum short term temperature of 142F).



Call our toll free number 800-848-5611 or visit our web site for the most current product and technical information at [www.itwredhead.com](http://www.itwredhead.com)



## MASONRY DESIGN TABLE

### C6+

For the Most Demanding Jobs

**Grout-filled Concrete Block: Threaded Rod Allowable Tension and Shear Loads Based on Steel Design Information for U.S. Customary Unit<sup>1,2,3</sup>**

Anchor Diameter (in.)	Tension (lb)			Shear (lb)		
	ASTM A307 F <sub>u</sub> = 60 ksi	ASTM A193 Grade B7 F <sub>u</sub> = 125 ksi	ASTM F593 SS 304 F <sub>u</sub> = 100 ksi	ASTM A307 F <sub>u</sub> = 60 ksi	ASTM A193 Grade B7 F <sub>u</sub> = 125 ksi	ASTM F593 SS 304 F <sub>u</sub> = 100 ksi
3/8	2,185	4,555	3,645	1,125	2,345	1,875
1/2	3,885	8,100	6,480	2,000	4,170	3,335
5/8	6,075	12,655	10,125	3,130	6,520	5,215
3/4	8,750	18,225	12,390	4,505	9,390	6,385

For SI: 1 inch = 25.4mm, 1 lbf = 4.45N, 1ft-lbf = 1.356 N-M, 1 psi = 0.006895 MPa

- 1 Allowable load used in the design must be the lesser of bond values and tabulated steel element values.
- 2 Allowable tension and shear loads for threaded rods to resist short term loads, such as wind or seismic, must be calculated in accordance with Section 4.1 of ICC ESR 4109 as applicable.
- 3 Allowable steel loads are based on allowable tension and shear stresses equal to 0.33X F<sub>u</sub> and 0.17X F<sub>u</sub>, respectively.

## MASONRY DESIGN TABLE

### C6+

For the Most Demanding Jobs

**Grout-filled Concrete Block: Threaded Rod Allowable Tension Loads with Reduction Factors<sup>1,2,3,4,7,9,10,12</sup>**

Threaded Rod Size (in.)	Minimum Embedment (inches)	Load at s <sub>cr</sub> and c <sub>cr</sub> (lb)	Spacing <sup>5</sup>			Edge Distance <sup>6</sup>		
			Critical s <sub>cr</sub> (inches)	Minimum s <sub>min</sub> (inches)	Load reduction factor for s <sub>min</sub> <sup>8</sup>	Critical c <sub>cr</sub> (inches)	Minimum c <sub>min</sub> (inches)	Load reduction factor for c <sub>min</sub> <sup>8</sup>
3/8	3-3/8	945	13.5	4	1.00	12	4	0.87
1/2	4-1/2	1,395	18	4	0.50	20	4	0.68
5/8	5-5/8	1,825	22.5	4	0.50	20	4	0.68
3/4	6-3/4	2,085	27	4	0.50	20	4	0.68

For SI: 1 inch = 25.4mm, 1 lbf = 0.0044kN, 1 ksi = 6.894 MPa

See footnotes below

## MASONRY DESIGN TABLE

### C6+

For the Most Demanding Jobs

**Grout-filled Concrete Block: Threaded Rod Allowable Shear Loads with Reduction Factors<sup>1,2,3,4,7,9,10,12</sup>**

Threaded Rod Size (in.)	Minimum Embedment (inches)	Load at s <sub>cr</sub> and c <sub>cr</sub> ⊥ to edge (lb)	Spacing <sup>5</sup>			Edge Distance <sup>6</sup>		
			Critical s <sub>cr</sub> (inches)	Minimum s <sub>min</sub> (inches)	Load reduction factor for s <sub>min</sub> <sup>8</sup>	Critical c <sub>cr</sub> (inches)	Minimum c <sub>min</sub> (inches)	Load reduction factor for c <sub>min</sub> <sup>8</sup>
3/8	3-3/8	825	13.5	4	0.50	12	4	0.87
1/2	4-1/2	1,560	18	4	0.50	20	4	0.56
5/8	5-5/8	2,680	22.5	4	0.50	20	4	0.30
3/4	6-3/4	3,180	27	4	0.50	20	4	0.27

For SI: 1 inch = 25.4mm, 1 lbf = 0.0044kN, 1 ksi = 6.894 MPa

- 1 All values are for anchors installed in fully grouted concrete masonry with minimum masonry strength of 1500 psi (10.3 MPa). Concrete masonry units must be light-, medium-, or normal-weight conforming to ASTM C 90. Allowable loads have been calculated using a safety factor of 5.0.
- 2 Anchors may be installed in any location in the face of the masonry wall (cell, web, bed joint) as shown in Figure 2 of ICC ESR 4109.
- 3 A maximum of two anchors may be installed in a single masonry cell in accordance with the spacing and edge or end distance requirements. Embedment is measured from the outside surface of the concrete masonry unit to the embedded end of the anchor.
- 4 The critical spacing distance, s<sub>cr</sub>, is the anchor spacing where full load values in the table may be used. The minimum spacing distance, s<sub>min</sub>, is the minimum anchor spacing for which values are available and installation is permitted. Spacing distance is measured from the centerline to centerline between two anchors.
- 5 The critical edge or end distance, c<sub>cr</sub>, is the distance where full load values in the table may be used. The minimum edge or end distance, c<sub>min</sub>, is the minimum distance for which values are available and installation is permitted. Edge or end distance is measured from anchor centerline to the closest unrestrained edge.
- 6 The tabulated values are applicable for anchors in the ends of grout-filled concrete masonry units where minimum edge distances are maintained.
- 7 Load values for anchors installed less than s<sub>cr</sub> and c<sub>cr</sub> must be multiplied by the appropriate load reduction factor based on actual spacing (s) or edge distance (c). Load factors are multiplicative; both spacing and edge reduction factors must be considered.
- 8 Linear interpolation of load values between minimum spacing (s<sub>min</sub>) and critical spacing (s<sub>cr</sub>) and between minimum edge or end distance (c<sub>min</sub>) and critical edge or end distance (c<sub>cr</sub>) is permitted.
- 9 Concrete masonry width (wall thickness) must be equal to or greater than 1.5 times the anchor embedment depth (e.g. 3/8-inch- and 1/2-inch-diameter anchors are permitted in minimum nominally 6-inch-thick concrete masonry). The 5/8- and 3/4-inch-diameter anchors must be installed in minimum nominally 8-inch-thick concrete masonry.
- 10 Allowable loads must be the lesser of the adjusted masonry or bond values tabulated above and the steel strength values given in Table 2 of ICC ESR 4109.
- 12 Tabulated allowable bond loads must be adjusted for increased in-service base material temperatures in accordance with Figure 1 of ICC ESR 4109 as applicable.

## MASONRY DESIGN TABLE

### C6+

For the Most Demanding Jobs

**Grout-filled Concrete Block: Rebar Allowable Tension and Shear Loads Based on Steel Design Information for U.S. Customary Unit<sup>1,2,3</sup>**

Rebar Size	Tension (lb)	Shear (lb)
	ASTM A615, Grade 60	ASTM A615, Grade 60
#3	3,270	1,685
#4	5,940	3,060
#5	9,205	4,745
#6	13,070	6,730

For SI: 1 inch = 25.4mm, 1 lbf = 4.45N, 1ft-lbf = 1.356 N-M, 1 psi = 0.006895 MPa

- 1 Allowable load used in the design must be the lesser of bond values and tabulated steel element values.
- 2 Allowable tension and shear loads for threaded rods to resist short term loads, such as wind or seismic, must be calculated in accordance with Section 4.1 of ICC ESR 4109 as applicable.
- 3 Allowable steel loads are based on allowable tension and shear stresses equal to 0.33X F<sub>u</sub> and 0.17X F<sub>u</sub>, respectively.

## MASONRY DESIGN TABLE

### C6+

For the Most Demanding Jobs

**Grout-filled Concrete Block: Rebar Allowable Tension Loads with Reduction Factors<sup>1,2,3,4,7,9,10,12</sup>**

Rebar Size	Minimum Embedment (inches)	Load at s <sub>cr</sub> and c <sub>cr</sub> (lb)	Spacing <sup>5</sup>			Edge Distance <sup>6</sup>		
			Critical s <sub>cr</sub> (inches)	Minimum s <sub>min</sub> (inches)	Load reduction factor for s <sub>min</sub> <sup>8</sup>	Critical c <sub>cr</sub> (inches)	Minimum c <sub>min</sub> (inches)	Load reduction factor for c <sub>min</sub> <sup>8</sup>
#3	3-3/8	785	13.5	4	1.00	12	4	0.87
#4	4-1/2	1,355	18	4	0.50	20	4	0.68
#5	5-5/8	2,060	22.5	4	0.50	20	4	0.68
#6	6-3/4	2,415	27	4	0.50	20	4	0.68

For SI: 1 inch = 25.4mm, 1 lbf = 0.0044kN, 1 ksi = 6.894 MPa

See footnotes below

## MASONRY DESIGN TABLE

### C6+

For the Most Demanding Jobs

**Grout-filled Concrete Block: Rebar Allowable Shear Loads with Reduction Factors<sup>1,2,3,4,7,9,10,12</sup>**

Rebar Size	Minimum Embedment (inches)	Load at s <sub>cr</sub> and c <sub>cr</sub> ⊥ to edge (lb)	Spacing <sup>5</sup>			Edge Distance <sup>6</sup>		
			Critical s <sub>cr</sub> (inches)	Minimum s <sub>min</sub> (inches)	Load reduction factor for s <sub>min</sub> <sup>8</sup>	Critical c <sub>cr</sub> (inches)	Minimum c <sub>min</sub> (inches)	Load reduction factor for c <sub>min</sub> <sup>8</sup>
#3	3-3/8	1,230	13.5	4	0.50	12	4	
#4	4-1/2	2,340	18	4	0.50	12	4	
#5	5-5/8	3,600	22.5	4	0.50	20	4	
#6	6-3/4	3,685	27	4	0.50	20	4	

For SI: 1 inch = 25.4 mm; 1 lbf = 0.0044 kN, 1 ksi = 6.894 MPa.

- 1 All values are for anchors installed in fully grouted concrete masonry with minimum masonry strength of 1500 psi (10.3 MPa). Concrete masonry units must be light-, medium, or normal-weight conforming to ASTM C 90. Allowable loads have been calculated using a safety factor of 5.0.
- 2 Anchors may be installed in any location in the face of the masonry wall (cell, web, bed joint) as shown in figure 2 of ICC ESR 4901.
- 3 A maximum of two anchors may be installed in a single masonry cell in accordance with the spacing and edge or end distance requirements. Embedment is measured from the outside surface of the concrete masonry unit to the embedded end of the anchor.
- 4 The critical spacing distance, s<sub>cr</sub>, is the anchor spacing where full load values in the table may be used. The minimum spacing distance, s<sub>min</sub>, is the minimum anchor spacing for which values are available and installation is permitted. Spacing distance is measured from the centerline to centerline between two anchors.
- 5 The critical edge or end distance, c<sub>cr</sub>, is the distance where full load values in the table may be used. The minimum edge or end distance, c<sub>min</sub>, is the minimum distance for which values are available and installation is permitted. Edge or end distance is measured from anchor centerline to the closest unrestrained edge.
- 6 The tabulated values are applicable for anchors in the ends of grout-filled concrete masonry units where minimum edge distances are maintained.
- 7 Load values for anchors installed less than s<sub>cr</sub> and c<sub>cr</sub> must be multiplied by the appropriate load reduction factor based on actual spacing (s) or edge distance (c). Load factors are multiplicative; both spacing and edge reduction factors must be considered.
- 8 Linear interpolation of load values between minimum spacing (s<sub>min</sub>) and critical spacing (s<sub>cr</sub>) and between minimum edge or end distance (c<sub>min</sub>) and critical edge or end distance (c<sub>cr</sub>) is permitted.
- 9 Concrete masonry width (wall thickness) must be equal to or greater than 1.5 times the anchor embedment depth (e.g. No. 3 and No. 4 reinforcing bars are permitted in minimum nominally 6-inch-thick concrete masonry). No. 5 and No. 6 reinforcing bars must be installed in minimum nominally 8-inch-thick concrete masonry.
- 10 Allowable loads must be the lesser of the adjusted masonry or bond values tabulated above and the steel strength values given in Table 4 of ICC ESR 4901.
- 12 Tabulated allowable bond loads must be adjusted for increased in-service base material temperatures in accordance with Figure 1 of ICC ESR 4901.



Call our toll free number 800-848-5611 or visit our web site for the most current product and technical information at [www.itwredhead.com](http://www.itwredhead.com)



# Umbrella Inserts and Screen Tubes

**High Performance Adhesive Systems for Fastening to Hollow Base Materials**



A7P-10

A7P-28

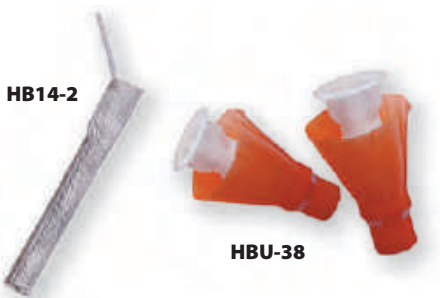

HB14-2

HBU-38

## DESCRIPTION/ADVANTAGES

### Hollow Block Fastening with A7+ or C6+ Adhesive

#### HBU-38

Umbrella Inserts—specially designed for fastening to the face of hollow concrete block, brick, clay tile or terracotta. Accepts rods 1/4", 3/8" and 1/2"

For umbrella to open correctly, air gap must be a minimum of 2-1/4"

#### SHORT SCREENS

Specially designed stainless steel screens provide maximum performance for a screen in the front face of hollow concrete block. Screens available for rods 1/4" to 5/8"

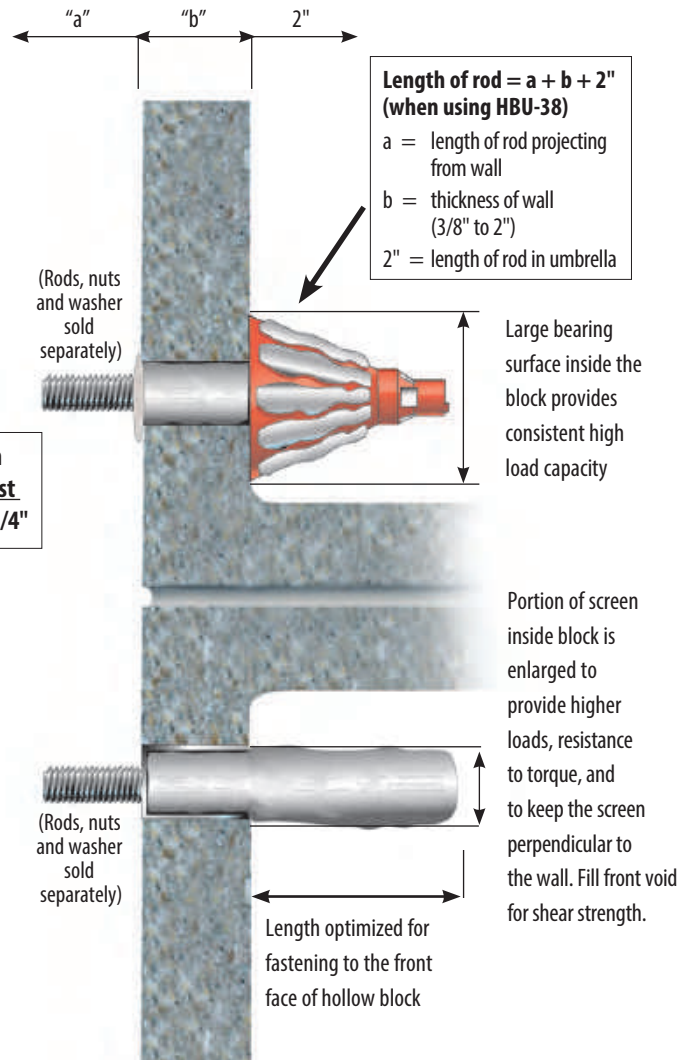

Section View—Concrete Block

### COMBINE WITH A7+ OR C6+ TO CREATE AN ADHESIVE FASTENING SYSTEM IDEAL FOR HOLLOW BLOCK, TERRACOTTA, CLAY TILE, MASONRY AND MORE

- Accepts 1/4", 3/8", and 1/2" threaded rods
- Use with A7+ Acrylic adhesive for fast dispensing, fast curing installation
- Use with C6+ Epoxy for fast curing extended working time installation



# Umbrella Inserts and Screens

## INSTALLATION STEPS

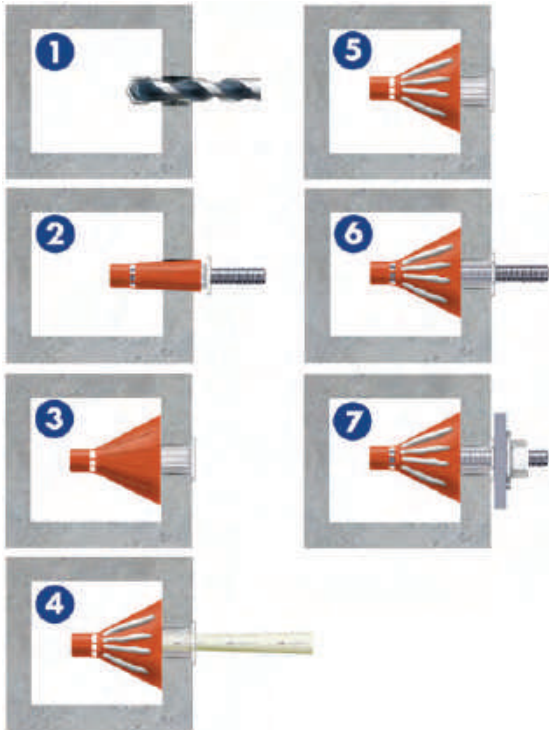

1. Drill 3/4" diameter hole, 3-3/4" deep using rotation only drilling mode and carbide tipped drill bit. Clean out hole with forced air. Complete hole preparation with use of a brush and repeat cleaning with compressed air (leave no dust or slurry).
2. Place umbrella on piece of threaded rod, stretch umbrella over the rod by pulling the white collar back approximately 1". Squeeze orange portion of umbrella and push umbrella into hole.
3. With the rod, push umbrella body through the hole and completely into void until umbrella opens behind wall. Remove threaded rod. (Do not use in solid base materials. For anchoring into block web, ends and mortar joints, use screens.)
4. Dispense and discard a sufficient amount of adhesive from new cartridge until a uniform adhesive mix is achieved. Inject approximately 1-1/2 fl. oz. of adhesive into umbrella (7 to 8 pumps using manual dispenser) to completely fill umbrella.
5. 3/8" rod uses a centering ring (supplied with inserts) to keep rod perpendicular to the wall.
6. Insert rod into the filled umbrella using a slow, soft twisting motion until it contacts the back of umbrella.
7. Wait for appropriate temperature/cure time before tightening fixture to the recommended torque of 10 ft./lbs.

Installation instructions for screens provided on page 53.

## SELECTION CHART

### Umbrella Inserts



DESCRIPTION	PART NO.	BOX CONTENTS
Umbrella Anchor 	HBU-38	20 Umbrellas 20 Centering Rings

## SELECTION CHART

### Short Screen Tubes



PART NO.	DESCRIPTION	QTY/BOX
HB14-2	1/4" x 2" Stainless Screen	100
HB38-312	3/8" x 3-1/2" Stainless Screen	100
HB12-312	1/2" x 3-1/2" Stainless Screen	50
HB58-412	5/8" x 4-1/2" Stainless Screen	50

## ESTIMATING TABLE

### Umbrella Inserts

**Number of Anchoring Installations Per Cartridge\* Using Threaded Rod and Umbrella Inserts with A7+ in Hollow Block**

ROD		DRILL HOLE DIA. INCHES	VOLUME OF CARTRIDGE	UMBRELLA INSERT WITH EMBEDMENT OF 3-3/4"
in.	(mm)			
3/8	(9.5)	3/4	A7+ 9.5 fluid oz.	6
			A7+ 28 fluid oz.	17

\* These estimates do not account for waste.



Call our toll free number 800-848-5611 or visit our web site for the most current product and technical information at [www.itwredhead.com](http://www.itwredhead.com)



## ESTIMATING TABLE

### Short Screens

**Number of Anchoring Installations per Cartridge\*  
Threaded Rod using Short Screen Tubes in A7+ in Hollow Block**

ROD		DRILL HOLE DIA. INCHES	VOLUME OF CARTRIDGE		SCREEN LENGTH PLUS 1 DIAMETER (inches)		
in.	(mm)				2"	3-1/2"	4-1/2"
1/4	(6.4)	3/8	A7+	9.5 fluid oz.	48		
			A7+	28 fluid oz.	135		
3/8	(9.5)	1/2	A7+	9.5 fluid oz.		21	
			A7+	28 fluid oz.		62	
1/2	(12.7)	5/8	A7+	9.5 fluid oz.		15	
			A7+	28 fluid oz.		43	
5/8	(15.9)	3/4	A7+	9.5 fluid oz.			11
			A7+	28 fluid oz.			24

\*These estimates do not account for waste

## PERFORMANCE TABLE

### Load Values<sup>1,2</sup>

**Hollow Concrete Block: Ultimate Tension and Shear Loads  
using Umbrellas and Short Screen Tubes<sup>1,2</sup>**

	ROD DIA.		MAX CLAMPING FORCE AFTER PROPER CURE		DRILL HOLE DIA.		EMBEDMENT (SCREEN LENGTH)		ULTIMATE TENSION		ULTIMATE SHEAR	
	in.	(mm)	ft. lbs.	(Nm)	in.	(mm)	in.	(mm)	lbs.	(Kn)	lbs.	(Kn)
Umbrella	3/8	(9.5)	10	(13)	3/4	(19.1)	3-3/4	(95.3)	3,600	(16)	3,200	(14.2)
	1/2"	(12.7)	10	(13)	3/4	(19.1)	3-3/4	(95.3)	3,600	(16)	3,200	(14.2)
Short Screen Tubes	1/4	(6.4)	4	(5)	3/8	(9.5)	2-1/4	(57.1)	1,550	(6.9)	1,900	(8.5)
	3/8	(9.5)	7	(9)	1/2	(12.7)	3-7/8	(98.4)	1,661	(7.4)	2,071	(9.2)
	1/2	(12.7)	10	(13)	5/8	(15.9)	4	(101.6)	2,458	(10.9)	4,467	(19.9)
	5/8	(15.9)	13	(17)	3/4	(19.1)	5-1/8	(130.2)	2,543	(10.9)	5,047	(22.4)

1 Allowable working loads should not exceed 20% ultimate capacity. Based upon testing using ASTM A193, Grade B7 rod. Divide by 5.

2 The tabulated values are for anchors installed at a minimum 12 inch edge distance and minimum 8 inch spacing.

# Screen Tubes

**Quality Adhesive  
Systems for  
Fastening Through  
Block and for  
Brick Pinning  
Applications**



A7P-10

A7P-28

Screen  
Tubes



## DESCRIPTION/SUGGESTED SPECIFICATIONS

### Screens Tubes Used with A7+ or C6+

#### HOLLOW CONCRETE BLOCK

Maximum holding strength in concrete block can be obtained by fastening to both the front and back of the block using an adhesive screen tube and threaded rod.

For attachment of screens to front face of a block, see Installation Steps below

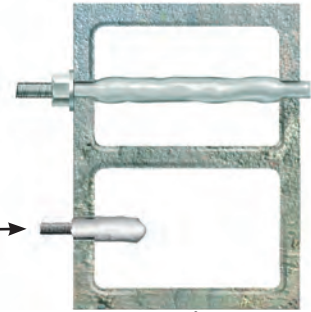

Top View

#### BRICK WALL

Systems designed for Seismic Retrofit, Brick Pinning or fastening to brick—various lengths and diameters available to accommodate site conditions.

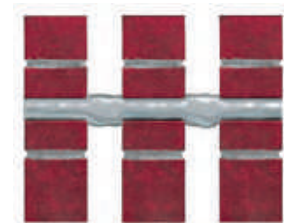

Section

The no-drip feature of A7+ adhesive makes it particularly well suited for brick pinning applications.

## ADVANTAGES

### HBP SERIES—NYLON SCREENS

- 30%-50% savings from stainless steel screens
- Comparable performance values
- Easier to insert and span across voids
- Flexible material is less susceptible to damage from crushing

### HB SERIES—STAINLESS SCREENS

- Corrosion resistant
- Available in 1/4" to 3/4" diameters
- Special version, "dosage control" available for overhead and underwater installations

## INSTALLATION STEPS



Hollow Base Material Screens

1. Drill hole to the length of the screen plus 1 diameter, using rotation-only drilling mode. Clean out hole with forced air. Complete hole preparation with use of a brush and repeat cleaning with forced air (leave no dust or slurry).



3. Insert the filled screen completely into the hole (subflush).

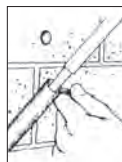

2. When starting new cartridge or new nozzle, dispense and discard enough adhesive until uniform adhesive mix is achieved. Insert the nozzle into the bottom of the screen and fill screen completely full (use extension tube if needed to reach bottom of screen).



4. While holding the tab of the screen against the wall, hand insert the selected rod slowly into the screen tube with a slow twisting motion. Pull screen flush to face and coat with adhesive. Wait for appropriate cure time before torquing fixture in place.

## SELECTION CHART

# Screen Tubes



HB Stainless Screen



HBP Nylon Screen

ROD DIA.		SCREEN LENGTH		STAINLESS STEEL SCREENS		NYLON SCREENS	
in.	(mm)	in.	(mm)	PART NO.	QTY/BOX	PART NO.	QTY/BOX
1/4	(6.4)	6	(152.4)	HB14-6	100		
1/4	(6.4)	8	(203.2)	HB14-8	100		
1/4	(6.4)	10	(254.0)	HB14-10	100		
3/8	(9.5)	6	(152.4)			HBP38-6	50
3/8	(9.5)	8	(203.2)			HBP38-8	25
3/8	(9.5)	10	(254.0)			HBP38-10	25
1/2	(12.7)	6	(152.4)			HBP12-6	50
1/2	(12.7)	8	(203.2)			HBP12-8	25
1/2	(12.7)	10	(254.0)			HBP12-10	25
5/8	(15.9)	6	(152.4)			HBP58-6	40
5/8	(15.9)	8	(203.2)			HBP58-8	40
5/8	(15.9)	10	(254.0)			HBP58-10	40
3/4	(19.1)	8	(203.2)	HB34-8	20		
3/4	(19.1)	10	(254.0)			HBP34-10	20
3/4	(19.1)	13	(330.2)			HBP34-13	20

\*Not available in standard strength nylon screens.

## ESTIMATING TABLE

# Screen Tubes

**Number of Holes per Cartridge\* using Threaded Rod and Screen Tubes with A7+ in Hollow Base Materials**

ROD		DRILL HOLE DIA. INCHES	VOLUME OF CARTRIDGE		SCREEN LENGTH				
in.	(mm)				6"	8"	10"	13"	
1/4	(6.4)	3/8	A7+	9.5 fluid oz.	16	12	10		
			A7+	28 fluid oz.	45	35	28		
3/8	(9.5)	1/2	A7+	9.5 fluid oz.	12	10	7.5		
			A7+	28 fluid oz.	37	29	23		
1/2	(12.7)	5/8	A7+	9.5 fluid oz.	9	6	5		
			A7+	28 fluid oz.	26	18	14		
5/8	(15.9)	3/4	A7+	9.5 fluid oz.	6	5	4		
			A7+	28 fluid oz.	18	14	10		
3/4	(19.1)	7/8	A7+	9.5 fluid oz.		3	2.5		1.75
			A7+	28 fluid oz.		9	6		5

\* These estimates do not account for waste.

# Accessories



### Wire Brush Extensions

**ESDS-38 EXTENSION WITH SDS+ ADAPTOR\***

**EHAN-38 EXTENSION WITH T-HANDLE\***

\* USABLE LENGTH IS 12", GOOD FOR ALL HOLES EXCEPT 7/16" DIAMETER

## DESCRIPTION/ADVANTAGES

### Wire Brushes

*Proper hole cleaning using a brush is essential to achieve optimum performance*



1/8" NPT  
(National Pipe Thread Taper)

PART No.	ANCHOR DIA.	REBAR DIA.	HOLE DIA.	OVERALL LENGTH	BRUSH DIA.	QTY/BAG
WB-038	3/8"	No. 3	7/16"	4-7/8"	5/8"	10
WB-012	1/2"	No. 4	5/8"	4-7/8"	3/4"	10
WB-058	5/8"	No. 5	3/4"	4-7/8"	1"	10
WB-034	3/4"	No. 6	7/8"	4-7/8"	1-1/4"	10
WB-078	7/8"	No. 7	1"	5-1/8"	1-1/2"	10
WB-100	1"	No. 8	1-1/8"	5-1/4"	1-5/8"	10
WB-125	1-1/4"	No. 10	1-3/8"	5-1/4"	1-3/4"	10
ESDS-38	Wire brush 12" usable extension with SDS+ adaptor					1
EHAN-38	Wire brush 12" usable extension with T-Handle					1

\* Proper hole cleaning using a wire brush is essential to achieve optimum performance. Brush may be used up to 50 holes depending on concrete strength. Brushes required for installation of No. 4, No. 8 rebar and larger are available with lead time.

### Plastic Extension Tubing

*Attaches to Adhesive System nozzles for deep hole installations*



DESCRIPTION	PART NO.	QTY
6-Foot Straight Tubing (.39 in. I.D. x .43 in. O.D.) (works with A245, S55, and E55 nozzle)	E25-6	6
6-Foot Long Extension Tube for use with Piston Plugs (works with all nozzles except S75)	E916-6	5

### Blow Pump



DESCRIPTION	PART NO.	QTY/BAG
Blow Pump	BP-10	1

Minimum hole 7/16".



# Selection Guide – Anchors for Concrete Applications

**ANCHOR TYPE**
**KEY FEATURES**
**SIZE RANGE (inches)**

## Trubolt® Wedge Anchors



ID STAMP



- 2018 IBC Compliant
- Seismic zone (A-B) approved
- Fully-threaded
- Length ID head stamped
- Stainless steel clip
- Through-fixture fastening

**Diameter:** 1/4 – 1  
**Length:** 1-3/4 – 10



## Large Diameter Tapcon (LDT)

Self-Threading Anchor



- Anti-rotation serrated washer
- Extra large hex washer head
- Length ID head stamped
- Through-fixture fastening

**LDT with Zinc Plating**  
**Diameter:** 3/8 – 3/4  
**Length:** 1-3/4 – 6-1/4



## Multi-Set II® Drop-In Anchors

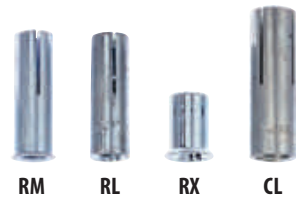

RM

RL

RX

CL

- RM: Flanged body to keep anchor flush with surface of concrete
- RL: Non-flanged body for recessed setting
- RX: Designed for hollow core and post tension concrete
- CL: Designed for one-sided forming, accepts coil rod

**Diameter:** 3/8 – 3/4  
**Length:** 1-5/8 – 3-3/16

**Diameter:** 1/4 – 3/4  
**Length:** 1 – 3-3/16

**Diameter:** 3/8 & 1/2  
**Length:** 3/4 – 1

**Diameter:** 1/2  
**Length:** 2

## Dynabolt® Sleeve Anchors



For both Hollow (1/4" &amp; 3/8" diameter) and Solid Concrete (1/4" through 3/4" diameter) Applications

- Concrete, block and brick
- Through-fixture fastening
- Available in 304 stainless steel

**Diameter:** 3/8 – 5/8  
**Length:** 1-7/8 – 5



## Tapcon®

Concrete Anchors with Advanced Threadform Technology™

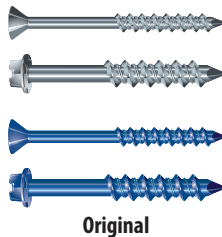

Original

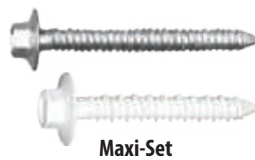

Maxi-Set

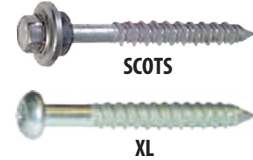

SCOTS

XL

# Selection Guide

	CORROSION RESISTANCE	PERFORMANCE	HEAD STYLES	APPROVALS/LISTINGS
<b>Trubolt® Wedge</b> cont'd	<ul style="list-style-type: none"> <li>■ Zinc-plated carbon steel to ASTM B633, SC1, Type III</li> <li>■ Hot dipped galvanized to ASTM A-153</li> <li>■ Type 304 and 316 stainless steel</li> </ul>	Ultimate Pullout Performance in 4,000 psi Concrete up to 26,540 lbs. (1" diameter)	Hex Nut and Tie-Wire version	ICC Evaluation Service, Inc. # ESR-2251 Underwriters Laboratories Factory Mutual Caltrans Meets or exceeds U.S. Government G.S.A. Specification A-A-1923A Type 4 (formerly GSA: FF-S-325 Group II, Type 4, Class 1)
<b>LDT</b> cont'd	<ul style="list-style-type: none"> <li>■ Zinc-plated carbon steel to ASTM B695 &amp; B633</li> <li>■ Type 410 stainless steel</li> </ul>	Ultimate Pullout Performance in 4,000 psi Concrete up to 23,268 lbs. (3/4" diameter)	Finished bolt style	
<b>Multi-Set II Drop-In</b> cont'd	<ul style="list-style-type: none"> <li>■ Zinc-plated carbon steel to ASTM B633, SC1, Type III</li> <li>■ Type 18-8 stainless steel</li> </ul>	Ultimate Pullout Performance in 4,000 psi Concrete up to 9,480 lbs. (3/4" diameter)	RM: Flanged body RL: Non-flanged body Use any bolt or threaded rod	GSA: A-A-55614 Type 1 (Formerly GSA: FF-S-325 Group VIII) Underwriters Laboratories Factory Mutual Caltrans
<b>Dynabolt® Sleeve</b> cont'd	<ul style="list-style-type: none"> <li>■ Zinc-plated carbon steel to ASTM B633, SC1, Type III</li> <li>■ Type 304 stainless steel</li> </ul>	Ultimate Pullout Performance in 4,000 psi Concrete up to 8,900 lbs. (3/4" diameter)	Flat head Hex nut Acorn nut Tie-Wire Round head Threshold flat head	GSA: A-A-1922A (Formerly GSA: FF-S-325 Group II, Type 3, Class 3) Factory Mutual
<b>Tapcon</b> cont'd	<ul style="list-style-type: none"> <li>■ Patented Trade Secret Climaseal® coating</li> <li>■ Type 410 stainless steel</li> </ul> <p>The above is for the Original and 410 SS Tapcon only. For data on other Tapcon products see their product pages as follows: Tapcon Maxi-Set on page 82, Tapcon SCOTS on page 84, Tapcon XL on page 86</p>	Ultimate Pullout Performance in 4,000 psi Concrete up to 2,380 lbs.	Hex head Star Drive flat head	<b>Blue Climaseal™</b> ICC Evaluation Service, Inc.— ESR-1671 ICC Evaluation Service, Inc.— ESR-2202 Miami-Dade County Florida Building Code <b>410 Stainless Steel</b> Miami-Dade County Florida Building Code

Because applications vary, ITW RED HEAD cannot guarantee the performance of this product. Each customer assumes all responsibility and risk for the use of this product. The safe handling and the suitability of this product for use is the sole responsibility of the customer. Specific job site conditions should be considered when selecting the proper product. Should you have any questions, please call the Technical Assistance Department at 800-848-5611.



Call our toll free number 800-848-5611 or visit our web site for the most current product and technical information at [www.itwredhead.com](http://www.itwredhead.com)



# Trubolt<sup>®</sup> Wedge Anchors

**Dependable,  
Heavy-Duty,  
Inspectible,  
Wedge Type  
Expansion  
Anchor**



**2018 IBC  
Compliant**

**Trubolt<sup>®</sup>**  
Wedge Anchors

## DESCRIPTION/SUGGESTED SPECIFICATIONS

### Wedge Type Anchors—

#### SPECIFIED FOR ANCHORAGE INTO CONCRETE

Trubolt Wedge anchors feature a stainless steel expansion clip, threaded stud body, nut and washer. Anchor bodies are made of plated carbon steel, hot-dipped galvanized carbon steel, type 304 stainless steel or type 316 stainless steel as identified in the drawings or other notations.

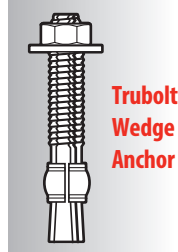

The exposed end of the anchor is stamped to identify anchor length. Stampings should be preserved during installation for any subsequent embedment verification.

Use carbide tipped hammer drill bits made in accordance with ANSI B212.15-1994 to install anchors.

Anchors are tested to ACI 355.2 and ICC-ES AC193. Anchors are listed by the following agencies as required by the local building code: ICC-ES, UL, FM, and Caltrans.

## ADVANTAGES

- 2018 International Building Code (IBC) Compliant for 1/4" through 1/2" diameters-carbon steel
- Versatile fully threaded design is standard on sizes up to 1" diameter and 10" length
- Anchor diameter equals hole diameter
- Standard carbon and stainless steel anchors
- Non bottom-bearing, may be used in hole depth exceeding anchor length
- Can be installed through the work fixture, eliminating hole spotting
- Inspectible torque values, indicating proper installation

### Fully Threaded Advantage

Trubolt's fully threaded feature eliminates subsurface obstruction problems.

Fully threaded design accommodates various material thicknesses at the same embedment. One anchor length saves time and money.

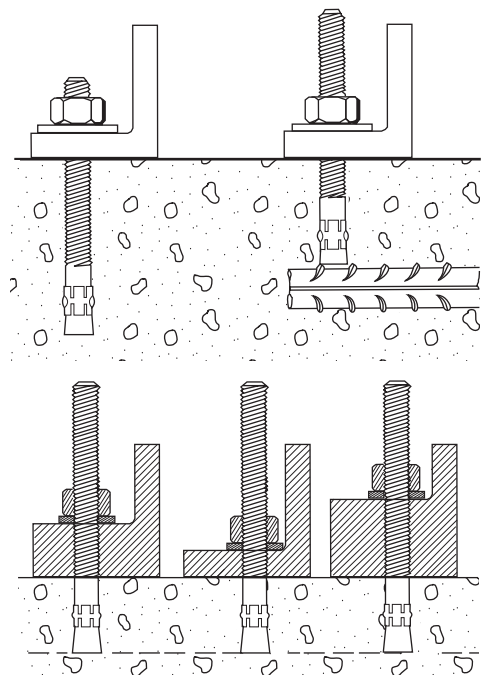

## APPLICATIONS



Anchoring machinery and conveyors is a common wedge anchor application. The Trubolt is fully threaded to allow a large range of embedment and fixture thickness.

## LENGTH INDICATION CODE\*

CODE	LENGTH OF ANCHOR		CODE	LENGTH OF ANCHOR	
	in.	mm		in.	mm
A	1-1/2 < 2	(38.1 < 50.8)	K	6-1/2 < 7	(165.1 < 177.8)
B	2 < 2-1/2	(50.8 < 63.5)	L	7 < 7-1/2	(177.8 < 190.5)
C	2-1/2 < 3	(63.5 < 76.2)	M	7-1/2 < 8	(190.5 < 203.2)
D	3 < 3-1/2	(76.2 < 88.9)	N	8 < 8-1/2	(203.2 < 215.9)
E	3-1/2 < 4	(88.9 < 101.6)	O	8-1/2 < 9	(215.9 < 228.6)
F	4 < 4-1/2	(101.6 < 114.3)	P	9 < 9-1/2	(228.6 < 241.3)
G	4-1/2 < 5	(114.3 < 127.0)	Q	9-1/2 < 10	(241.3 < 254.0)
H	5 < 5-1/2	(127.0 < 139.7)	R	10 < 11	(254.0 < 279.4)
I	5-1/2 < 6	(139.7 < 152.4)	S	11 < 12	(279.4 < 304.8)
J	6 < 6-1/2	(152.4 < 165.1)	T	12 < 13	(304.8 < 330.2)

\*Located on top of anchor for easy inspection.

## FEATURES



**Length ID Head Stamp**—provides for embedment inspection after installation

**Fully Threaded Design**

**Cold-Formed**—manufacturing process adds strength

**Stainless steel split expansion ring**

**Anchor Body**—available in zinc-plated steel, hot-dipped galvanized steel, 304 stainless steel and 316 stainless steel

### TRUBOLT® WEDGE ANCHOR

## APPROVALS/LISTINGS

### Trubolt® Wedge Anchors

ICC Evaluation Service, Inc. ESR-2251

- Category 1 performance rating
- 2018 IBC compliant
- Meets ACI 318 ductility requirements
- Tested in accordance with ACI 355.2 and ICC-ES AC193
- For use in seismic zones A & B
- 1/4", 3/8" & 1/2" diameter anchors listed in ESR-2251

Underwriters Laboratories

Factory Mutual

Caltrans

Meets or exceeds U.S. Government G.S.A. Specification A-A-1923A Type 4 (formerly GSA: FF-S-325 Group II, Type 4, Class 1)



## INSTALLATION STEPS

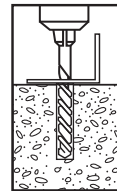

1. Select a carbide drill bit with a diameter equal to the anchor diameter. Drill hole to any depth exceeding the desired embedment. See chart for minimum recommended embedment.

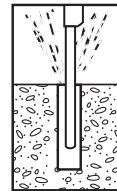

2. Clean hole or continue drilling additional depth to accommodate drill fines.



3. Assemble washer and nut, leaving top of stud exposed through nut. Drive anchor through material to be fastened until washer is flush to surface of material.



4. Expand anchor by tightening nut 3 to 5 full turns past the hand tight position, or to the specified torque requirement.

\*\* ONLY FOR USE IN CONCRETE\*\*

## SELECTION CHART

# Trubolt Wedge

Carbon Steel w/Zinc Plating

Meets ASTM B633 SC1, Type III specifications for electroplating of 5um = .0002" thickness. This material is well suited for non-corrosive environments.



**Typical Applications**—  
Structural Columns,  
Machinery, Equipment, etc.  
**Environment**—Interior  
(non-corrosive)  
**Level of Corrosion**—Low

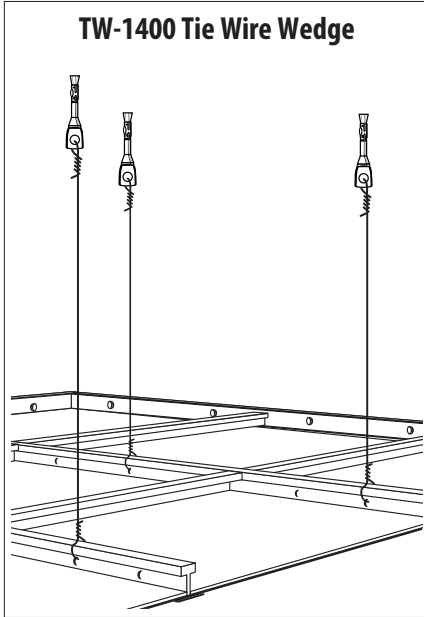

PART NUMBER	THREAD LENGTH		ANCHOR DIA. & DRILL BIT SIZE (THREADS) PER INCH	OVERALL LENGTH		MAX. THICKNESS OF MATERIALS TO BE FASTENED		QTY/WT PER BOX		QTY/WT PER MASTER CARTON	
	in.	(mm)		in.	(mm)	in.	(mm)	qty.	lbs.	qty.	lbs.
WS-1416	3/4	(19.1)	1/4" - 20	1-3/4	(44.5)	3/8	(9.5)	100	3.1	1000	32
WS-1422	1-1/4	(31.8)		2-1/4	(57.2)	7/8	(22.2)	100	3.6	1000	37
WS-1432	2-1/4	(57.2)		3-1/4	(82.6)	1-7/8	(47.6)	100	4.7	800	39
WS-3822	1-1/8	(28.6)	3/8" - 16	2-1/4	(57.2)	3/8	(9.5)	50	4.1	500	41
WS-3826	1-5/8	(41.3)		2-3/4	(69.9)	7/8	(22.2)	50	4.7	400	39
WS-3830	1-3/4	(44.5)		3	(76.2)	1-1/8	(28.6)	50	5.0	400	41
WS-3836	2-1/2	(63.5)		3-3/4	(95.3)	1-7/8	(47.6)	50	5.9	300	36
WS-3850	3-3/4	(95.2)		5	(127.0)	3-1/8	(79.4)	50	7.4	250	38
WS-3870	3-7/8	(98.4)	7	(177.8)	5-1/8	(130.2)	50	10.4	250	53	
WS-1226	1-1/4	(31.8)	1/2" - 13	2-3/4	(69.9)	1/8	(3.2)	25	4.6	200	38
WS-1236	2-1/4	(57.2)		3-3/4	(95.3)	1	(25.4)	25	5.7	150	35
WS-1242	2-3/4	(69.9)		4-1/4	(108.0)	1-1/2	(38.1)	25	6.2	150	38
WS-1244	3	(76.2)		4-1/2	(114.3)	1-3/4	(44.5)	25	6.5	150	39
WS-1254	4	(101.6)		5-1/2	(139.7)	2-3/4	(69.9)	25	7.7	150	47
WS-1270	5-1/2	(139.7)	7	(177.8)	4-1/4	(108.0)	25	9.3	150	57	
WS-5834	1-3/4	(44.5)	5/8" - 11	3-1/2	(88.9)	1/8	(3.2)	10	3.6	100	37
WS-5850	3-1/4	(82.6)		5	(127.0)	1-5/8	(41.3)	10	4.7	100	48
WS-5860	4-1/4	(107.9)		6	(152.4)	2-5/8	(66.7)	10	5.4	50	28
WS-5870	5-1/4	(133.4)		7	(177.8)	3-5/8	(92.1)	10	6.2	30	19
WS-5884	5-3/4	(146.0)	8-1/2	(215.9)	5-1/8	(130.2)	10	8.0	30	25	
WS-3446	2-7/8	(73.0)	3/4" - 10	4-3/4	(120.7)	3/4	(19.1)	10	7.4	60	45
WS-3454	3-5/8	(92.1)		5-1/2	(139.7)	1-1/2	(38.1)	10	8.1	50	41
WS-3462	4-3/8	(111.1)		6-1/4	(158.8)	2-1/4	(57.2)	10	9.1	30	28
WS-3470	5-1/8	(130.2)		7	(177.8)	3	(76.2)	10	9.7	30	30
WS-3484	5-3/4	(146.0)		8-1/2	(215.9)	4-1/2	(114.3)	10	12.3	30	38
WS-34100	5-3/4	(146.0)		10	(254.0)	6	(152.4)	10	14.0	30	43
<b>TIE WIRE</b>											
TW-1400	N/A		1/4"	2-1/8	(54.0)	9/32-hole	(7.1)	100	3.6	1000	36

## SELECTION CHART

# Trubolt Wedge

Carbon Steel w/  
Hot Dipped Galvanizing

Meets ASTM A153 Class specifications for hot-dipped galvanizing > 45um = .002". It is highly recommended for damp, humid environments near coastal regions. Hot-dipped galvanized Trubolts have a coating thickness of zinc that is almost 10 times as thick as electroplating. This creates greater corrosion resistance at a minimal cost.



**Typical Applications**—  
Railings, Signage, Awnings,  
etc.  
**Environment**—Rural/  
Suburban (exterior  
environment—essentially  
unpolluted areas)  
**Level of Corrosion**—  
Low to Medium

PART NUMBER	THREAD LENGTH		ANCHOR DIA. & DRILL BIT SIZE (THREADS) PER INCH	OVERALL LENGTH		MAX. THICKNESS OF MATERIALS TO BE FASTENED		QTY/WT PER BOX		QTY/WT PER MASTER CARTON	
	in.	(mm)		in.	(mm)	in.	(mm)	qty.	lbs.	qty.	lbs.
WS-1242G	2-3/4	(69.9)	1/2" - 13	4-1/4	(108.0)	1-1/2	(38.1)	25	6.7	150	41
WS-1254G	4	(101.6)		5-1/2	(139.7)	2-3/4	(69.9)	25	8.0	150	49
WS-1270G	5-1/2	(139.7)		7	(177.8)	4-1/4	(108.0)	25	9.7	150	59
WS-5860G	4-1/4	(107.9)	5/8" - 11	6	(152.4)	2-5/8	(66.7)	10	5.6	50	29
WS-3454G	3-5/8	(92.1)	3/4" - 10	5-1/2	(139.7)	1-1/2	(38.1)	10	8.4	50	42



## SELECTION CHARTS

# Trubolt Wedge

## 304 Stainless Steel

Serves many applications well. It withstands rusting in architectural and food processing environments and resists organic chemicals, dye stuffs and many inorganic chemicals.



**Typical Applications**—  
Cladding, Stadium Seating, etc.  
**Environment**—Urban  
(slight to moderate  
degree of pollution)  
**Level of Corrosion**—Medium

PART NUMBER	THREAD LENGTH		ANCHOR DIA. & DRILL BIT SIZE (THREADS) PER INCH	OVERALL LENGTH		MAX. THICKNESS OF MATERIALS TO BE FASTENED		QTY/WT PER BOX		QTY/WT PER MASTER CARTON		
	in.	(mm)		in.	(mm)	in.	(mm)	qty.	lbs.	qty.	lbs.	
WW-1416	3/4	(19.1)	1/4" - 20	1-3/4	(44.5)	3/8	(9.5)	100	3.2	1000	32	
WW-1422	1-1/4	(31.8)		2-1/4	(57.2)	7/8	(22.2)	100	3.7	1000	37	
WW-1432	2-1/4	(57.2)		3-1/4	(82.6)	1-7/8	(47.6)	100	4.8	800	39	
WW-3822	1-1/8	(28.6)	3/8" - 16	2-1/4	(57.2)	3/8	(9.5)	50	4.1	500	41	
WW-3826	1-5/8	(41.3)		2-3/4	(69.9)	7/8	(22.2)	50	4.8	400	39	
WW-3830	1-3/4	(44.5)		3	(76.2)	1-1/8	(28.6)	50	5.1	400	42	
WW-3836	2-1/2	(63.5)		3-3/4	(95.3)	1-7/8	(47.6)	50	6.0	300	37	
WW-3850	3-3/4	(95.3)		5	(127.0)	3-1/8	(79.4)	50	7.5	250	39	
WW-1226	1-1/4	(31.8)	1/2" - 13	2-3/4	(69.9)	1/8	(3.2)	25	4.7	200	38	
WW-1236	2-1/4	(57.2)		3-3/4	(95.3)	1	(25.4)	25	5.8	150	36	
WW-1242	2-3/4	(69.9)		4-1/4	(108.0)	1-1/2	(38.1)	25	6.3	150	39	
WW-1254	3	(76.2)		5-1/2	(139.7)	2-3/4	(69.9)	25	7.7	150	47	
WW-1270	3-1/2	(88.9)		7	(177.8)	4-1/4	(108.0)	25	9.4	150	57	
WW-5834	1-3/4	(44.5)		5/8" - 11	3-1/2	(88.9)	1/8	(3.2)	10	3.6	100	37
WW-5842	2-1/2	(63.5)			4-1/4	(108.0)	7/8	(22.2)	10	4.2	100	43
WW-5850	3-1/4	(82.6)	5		(127.0)	1-5/8	(41.3)	10	4.8	100	49	
WW-5860	4-1/4	(107.9)	6		(152.4)	2-5/8	(66.7)	10	5.5	50	28	
WW-5870	3-1/2	(88.9)	7		(177.8)	3-5/8	(92.1)	10	6.2	30	20	
WW-5884	3-1/2	(88.9)	8-1/2		(215.9)	5-1/8	(130.2)	10	8.0	30	25	
WW-3446	2-7/8	(73.0)	4-3/4		(120.7)	3/4	(19.1)	10	6.7	60	41	
WW-3454	3-5/8	(92.1)	5-1/2	(139.7)	1-1/2	(38.1)	10	7.5	50	38		
WW-3462	4-3/8	(111.1)	3/4" - 10	6-1/4	(158.8)	2-1/4	(57.2)	10	9.1	30	28	
WW-3470	3-1/2	(88.9)		7	(177.8)	3	(76.2)	10	9.2	30	28	
WW-3484	3-1/2	(88.9)		8-1/2	(215.9)	4-1/2	(114.3)	10	12.3	30	38	
WW-34100	1-3/4	(44.5)		10	(254.0)	6	(152.4)	10	13.5	30	42	
WW-10060	2-1/2	(63.5)		1" - 8	6	(152.4)	1/2	(12.7)	5	8.3	25	43
WW-10090	2-1/2	(63.5)	9		(228.6)	3-1/2	(88.9)	5	11.4	15	35	

\* For continuous extreme low temperature applications, use stainless steel.

## SELECTION CHARTS

# Trubolt Wedge

## 316 Stainless Steel

Contains more nickel and chromium than Type 304, and 2%-3% molybdenum, which gives it better corrosion resistance. It is especially more effective in chloride environments that tend to cause pitting.



**Typical Applications**—  
Pumps, Diffusers, Gates,  
Weir Plates, etc.  
**Environment**—Industrial  
(moderate to heavy  
atmospheric pollution)  
**Level of Corrosion**—  
Medium to High



**Typical Applications**—  
Tunnels, Dams, Tiles,  
Lighting Fixtures, etc.  
**Environment**—  
Marine (heavy atmospheric  
pollution)  
**Level of Corrosion**—High

PART NUMBER	THREAD LENGTH		ANCHOR DIA. & DRILL BIT SIZE (THREADS) PER INCH	OVERALL LENGTH		MAX. THICKNESS OF MATERIALS TO BE FASTENED		QTY/WT PER BOX		QTY/WT PER MASTER CARTON	
	in.	(mm)		in.	(mm)	in.	(mm)	qty.	lbs.	qty.	lbs.
SWW-1422	1-1/4	(31.8)	1/4" - 20	2-1/4	(57.2)	7/8	(22.2)	100	3.7	1000	37
SWW-1432	2-1/4	(57.2)		3-1/4	(82.6)	1-1/8	(28.6)	100	4.8	1000	39
SSW-3830	1-3/4	(44.5)		3	(76.2)	1-1/8	(28.6)	50	5.2	400	42
SWW-3836	2-1/2	(63.5)	3/8" - 16	3-3/4	(95.5)	1-7/8	(47.6)	50	6.0	300	37
SWW-3850	3-3/4	(95.3)		5	(127.0)	3-1/8	(79.4)	50	7.5	250	39
SWW-1236	2-1/4	(57.2)	1/2" - 13	3-3/4	(95.3)	1	(25.4)	25	5.8	150	36
SWW-1242	2-3/4	(69.9)		4-1/4	(108.0)	1-1/2	(38.1)	25	6.5	150	40
SWW-1254	3	(76.2)		5-1/2	(139.7)	2-3/4	(69.9)	25	7.8	150	48
SWW-5850	3-1/4	(82.6)		5/8" - 11	5	(127.0)	1-5/8	(41.3)	10	4.8	100

\* For continuous extreme low temperature applications, use stainless steel.



Call our toll free number 800-848-5611 or visit our web site for the most current product and technical information at [www.itwedhead.com](http://www.itwedhead.com)



**PERFORMANCE TABLE**

**Trubolt**  
Wedge Anchors

**Ultimate Tension and Shear Values (lbs/kN)  
in Solid Concrete\***

ANCHOR DIA.		INSTALLATION TORQUE		EMBEDMENT DEPTH		ANCHOR TYPE	f'c + 2,000 PSI (13.8 MPa)				f'c + 4,000 PSI (27.6 MPa)				f'c + 6,000 PSI (41.4 MPa)			
in.	(mm)	ft. lbs.	(Nm)	in.	(mm)		TENSION		SHEAR		TENSION		SHEAR		TENSION		SHEAR	
							lbs.	(kN)	lbs.	(kN)	lbs.	(kN)	lbs.	(kN)	lbs.	(kN)	lbs.	(kN)
1/4	(6.4)	4	(5.4)	1-1/8	(28.6)	WS-Carbon or WS-G Hot-Dipped Galvanized or WW-304 S.S. or SWW-316 S.S.	1,180	(5.2)	1,400	(6.2)	1,780	(7.9)	1,400	(6.2)	1,900	(8.5)	1,400	(6.2)
				1-15/16	(49.2)		2,100	(9.3)	1,680	(7.5)	3,300	(14.7)	1,680	(7.5)	3,300	(14.7)	1,680	(7.5)
				2-1/8	(54.0)		2,260	(10.1)	1,680	(7.5)	3,300	(14.7)	1,680	(7.5)	3,300	(14.7)	1,680	(7.5)
3/8	(9.5)	25	(33.9)	1-1/2	(38.1)		1,620	(7.5)	2,320	(10.3)	2,240	(10.0)	2,620	(11.7)	2,840	(12.6)	3,160	(14.1)
				3	(76.2)		3,480	(15.5)	4,000	(17.8)	5,940	(26.4)	4,140	(18.4)	6,120	(27.2)	4,500	(20.0)
				4	(101.6)		4,800	(21.4)	4,000	(17.8)	5,940	(26.4)	4,140	(18.4)	6,120	(27.2)	4,500	(20.0)
1/2	(12.7)	55	(74.6)	2-1/4	(57.2)		3,455	(20.7)	4,760	(21.2)	4,920	(22.7)	4,760	(21.2)	6,025	(31.3)	7,040	(31.3)
				4-1/8	(104.8)		4,660	(20.7)	7,240	(32.2)	9,640	(42.9)	7,240	(32.2)	10,820	(48.1)	8,160	(36.3)
				6	(152.4)		5,340	(23.8)	7,240	(32.2)	9,640	(42.9)	7,240	(32.2)	10,820	(48.1)	8,160	(36.3)
5/8	(15.9)	90	(122.0)	2-3/4	(69.9)		5,185	(29.3)	7,120	(31.7)	7,180	(31.9)	7,120	(31.7)	9,225	(43.2)	9,616	(42.8)
				5-1/8	(130.2)		6,580	(29.3)	9,600	(42.7)	14,920	(66.4)	11,900	(52.9)	16,380	(72.9)	12,520	(55.7)
				7-1/2	(190.5)		7,060	(31.4)	9,600	(42.7)	15,020	(66.8)	11,900	(52.9)	16,380	(72.9)	12,520	(55.7)
3/4	(19.1)	110	(149.2)	3-1/4	(82.6)	6,765	(31.7)	10,120	(45.0)	10,840	(48.2)	13,720	(61.0)	13,300	(59.2)	15,980	(71.1)	
				6-5/8	(168.3)	10,980	(48.8)	20,320	(90.4)	17,700	(78.7)	23,740	(105.6)	20,260	(90.1)	23,740	(105.6)	
				10	(254.0)	10,980	(48.8)	20,320	(90.4)	17,880	(79.5)	23,740	(105.6)	23,580	(104.9)	23,740	(105.6)	
7/8	(22.2)	250	(339.0)	3-3/4	(95.3)	9,290	(42.3)	13,160	(58.5)	14,740	(65.6)	16,580	(73.8)	17,420	(77.5)	19,160	(85.2)	
				6-1/4	(158.8)	14,660	(65.2)	20,880	(92.9)	20,940	(93.1)	28,800	(128.1)	24,360	(108.4)	28,800	(128.1)	
				8	(203.2)	14,660	(65.2)	20,880	(92.9)	20,940	(93.1)	28,800	(128.1)	24,360	(108.4)	28,800	(128.1)	
1	(25.4)	300	(406.7)	4-1/2	(114.3)	11,770	(62.0)	16,080	(71.5)	19,245	(89.8)	22,820	(101.5)	21,180	(94.2)	24,480	(108.9)	
				7-3/8	(187.3)	14,600	(64.9)	28,680	(127.6)	23,980	(106.7)	37,940	(168.8)	33,260	(148.0)	38,080	(169.4)	
				9-1/2	(241.3)	18,700	(83.2)	28,680	(127.6)	26,540	(118.1)	37,940	(168.8)	33,260	(148.0)	38,080	(169.4)	
1/4	(6.4)	N/A		1-1/8	(28.6)	Tie-Wire Wedge Anchor	1072	(4.8)	1523	(6.8)	1516	(6.7)	2154	(9.6)	1625	(7.2)	2492	(11.1)

\* To calculate the Allowable Load of the anchor, divide the Ultimate Load by 4.  
\* For continuous extreme low temperature applications, use stainless steel.

**PERFORMANCE TABLE**

**Trubolt**  
Wedge Anchors

**Ultimate Tension and Shear Values (lbs/kN)  
in Lightweight Concrete\***

ANCHOR DIA.		INSTALLATION TORQUE		EMBEDMENT DEPTH		ANCHOR TYPE	LIGHTWEIGHT CONCRETE f'c + 3,000 PSI (20.7 MPa)				LOWER FLUTE OF STEEL DECK WITH LIGHTWEIGHT CONCRETE FILL f'c + 3,000 PSI (20.7 MPa)			
in.	(mm)	ft. lbs.	(Nm)	in.	(mm)		TENSION		SHEAR		TENSION		SHEAR	
							lbs.	(kN)	lbs.	(kN)	lbs.	(kN)	lbs.	(kN)
3/8	(9.5)	25	(33.9)	1-1/2	(38.1)	WS-Carbon or WS-G Hot-Dipped Galvanized or WW-304 S.S. or SWW-316 S.S.	1,175	(5.2)	1,480	(6.6)	1,900	(8.5)	3,160	(14.1)
				3	(76.2)		2,825	(12.6)	2,440	(10.9)	2,840	(12.6)	4,000	(17.8)
1/2	(12.7)	55	(74.6)	2-1/4	(57.2)		2,925	(13.0)	2,855	(12.7)	3,400	(15.1)	5,380	(23.9)
				3	(76.2)		3,470	(15.4)	3,450	(15.3)	4,480	(19.9)	6,620	(29.4)
				4	(101.6)		4,290	(19.1)	3,450	(15.3)	4,800	(21.4)	6,440	(28.6)
5/8	(15.9)	90	(122.0)	3	(76.2)		4,375	(19.5)	4,360	(19.4)	4,720	(21.0)	5,500	(24.5)
				5	(127.0)		6,350	(28.2)	6,335	(28.2)	6,580	(29.3)	9,140	(40.7)
3/4	(19.1)	110	(149.2)	3-1/4	(82.6)		5,390	(24.0)	7,150	(31.8)	5,840	(26.0)	8,880	(39.5)
				5-1/4	(133.4)		7,295	(32.5)	10,750	(47.8)	7,040	(31.3)	N/A	N/A

\* To calculate the Allowable Load of the anchor, divide the Ultimate Load by 4.

## PERFORMANCE TABLE

### Trubolt Wedge Anchors

### Recommended Edge and Spacing Distance Requirements for Tension Loads\*

ANCHOR DIA.		EMBEDMENT DEPTH		ANCHOR TYPE	EDGE DISTANCE REQUIRED TO OBTAIN MAX. WORKING LOAD		MIN. ALLOWABLE EDGE DISTANCE AT WHICH THE LOAD FACTOR APPLIED = .65		SPACING REQUIRED TO OBTAIN MAX. WORKING LOAD		MIN. ALLOWABLE SPACING AT WHICH THE LOAD FACTOR APPLIED = .70	
in.	(mm)	in.	(mm)		in.	(mm)	in.	(mm)	in.	(mm)	in.	(mm)
1/4	(6.4)	1-1/8	(28.6)	WS-Carbon or WS-G Hot-Dipped Galvanized or WW-304 S.S. or SWW-316 S.S.	2	(50.8)	1	(25.4)	3-15/16	(100.0)	2	(50.8)
		1-15/16	(49.2)		1-15/16	(49.2)	1	(25.4)	3-7/8	(98.4)	1-15/16	(49.2)
		2-1/8	(54.0)		1-5/8	(41.3)	13/16	(20.6)	3-3/16	(81.0)	1-5/8	(41.3)
3/8	(9.5)	1-1/2	(38.1)		2-5/8	(66.7)	1-5/16	(33.3)	5-1/4	(133.4)	2-5/8	(66.7)
		3	(76.2)		3	(76.2)	1-1/2	(38.1)	6	(152.4)	3	(76.2)
		4	(101.6)		3	(76.2)	1-1/2	(38.1)	6	(152.4)	3	(76.2)
1/2	(12.7)	2-1/4	(57.2)		3-15/16	(100.0)	2	(50.8)	7-7/8	(200.0)	3-15/16	(100.0)
		4-1/8	(104.8)		3-1/8	(79.4)	1-9/16	(39.7)	6-3/16	(157.2)	3-1/8	(79.4)
		6	(152.4)		4-1/2	(114.3)	2-1/4	(57.2)	9	(228.6)	4-1/2	(114.3)
5/8	(15.9)	2-3/4	(69.9)		4-13/16	(122.2)	2-7/16	(61.9)	9-5/8	(244.5)	4-13/16	(122.2)
		5-1/8	(130.2)		3-7/8	(98.4)	1-15/16	(49.2)	7-1/16	(195.3)	3-7/8	(98.4)
		7-1/2	(190.5)		5-5/8	(142.9)	2-13/16	(71.4)	11-1/4	(285.8)	5-5/8	(142.9)
3/4	(19.1)	3-1/4	(82.6)		5-11/16	(144.5)	2-7/8	(73.0)	11-3/8	(288.9)	5-11/16	(144.5)
		6-5/8	(168.3)		5	(127.0)	2-1/2	(63.5)	9-15/16	(252.4)	5	(127.0)
		10	(254.0)		7-1/2	(190.5)	3-3/4	(95.3)	15	(381.0)	7-1/2	(190.5)
7/8	(22.2)	3-3/4	(95.3)		6-9/16	(166.7)	3-5/16	(84.1)	13-1/8	(333.4)	6-9/16	(166.7)
		6-1/4	(158.8)		6-1/4	(158.8)	3-1/8	(79.4)	12-1/2	(317.5)	6-1/4	(158.8)
		8	(203.2)		6	(152.4)	3	(76.2)	12	(304.8)	6	(152.4)
1	(25.4)	4-1/2	(114.3)	7-7/8	(200.0)	3-15/16	(100.0)	15-3/4	(400.1)	7-7/8	(200.0)	
		7-3/8	(187.3)	7-3/8	(187.3)	3-11/16	(93.7)	14-3/4	(374.7)	7-3/8	(187.3)	
		9-1/2	(241.3)	7-1/8	(181.0)	3-9/16	(90.5)	14-1/4	(362.0)	7-1/8	(181.0)	

\* Spacing and edge distances shall be divided by 0.75 when anchors are placed in structural lightweight concrete. Linear interpolation may be used for intermediate spacing and edge distances.

## PERFORMANCE TABLE

### Trubolt Wedge Anchors

### Recommended Edge and Spacing Distance Requirements for Shear Loads\*

ANCHOR DIA.		EMBEDMENT DEPTH		ANCHOR TYPE	EDGE DISTANCE REQUIRED TO OBTAIN MAX. WORKING LOAD		MIN. EDGE DISTANCE AT WHICH THE LOAD FACTOR APPLIED = .60		MIN. EDGE DISTANCE AT WHICH THE LOAD FACTOR APPLIED = .20		SPACING REQUIRED TO OBTAIN MAX. WORKING LOAD		MIN. ALLOWABLE SPACING BETWEEN ANCHORS in. (mm) LOAD FACTOR APPLIED = .40	
in.	(mm)	in.	(mm)		in.	(mm)	in.	(mm)	in.	(mm)	in.	(mm)	in.	(mm)
1/4	(6.4)	1-1/8	(28.6)	WS-Carbon or WS-G Hot-Dipped Galvanized or WW-304 S.S. or SWW-316 S.S.	2	(50.8)	1-5/16	(33.3)	N/A	N/A	3-15/16	(100.0)	2	(50.8)
		1-15/16	(49.2)		1-15/16	(49.2)	1	(25.4)	N/A	N/A	3-7/8	(98.4)	1-15/16	(49.2)
3/8	(9.5)	1-1/2	(38.1)		2-5/8	(66.7)	1-3/4	(44.5)	N/A	N/A	5-1/4	(133.4)	2-5/8	(66.7)
		3	(76.2)		3-3/4	(95.3)	3	(76.2)	1-1/2	(38.1)	6	(152.4)	3	(76.2)
1/2	(12.7)	2-1/4	(57.2)		3-15/16	(100.0)	2-9/16	(65.1)	N/A	N/A	7-7/8	(200.0)	3-15/16	(100.0)
		4-1/8	(104.8)		5-3/16	(131.8)	3-1/8	(79.4)	1-9/16	(39.7)	6-3/16	(157.2)	3-1/8	(79.4)
5/8	(15.9)	2-3/4	(69.9)		4-13/16	(122.2)	3-1/8	(79.4)	N/A	N/A	9-5/8	(244.5)	4-13/16	(122.2)
		5-1/8	(130.2)		6-7/16	(163.5)	3-7/8	(98.4)	1-15/16	(49.2)	7-11/16	(195.3)	3-7/8	(98.4)
3/4	(19.1)	3-1/4	(82.6)		5-11/16	(144.5)	3-3/4	(95.3)	N/A	N/A	11-3/8	(288.9)	5-11/16	(144.5)
		6-5/8	(168.3)		6-5/16	(160.3)	5	(127.0)	2-1/2	(63.5)	9-15/16	(252.4)	5	(127.0)
7/8	(22.2)	3-3/4	(95.3)		6-9/16	(166.7)	4-5/16	(109.5)	N/A	N/A	13-1/8	(333.4)	6-9/16	(166.7)
		6-1/4	(158.8)		8-1/2	(215.9)	6-1/4	(158.8)	3-1/8	(79.4)	12-1/2	(317.5)	6-1/4	(158.8)
1	(25.4)	4-1/4	(108.0)		7-7/8	(200.0)	5-1/8	(130.2)	N/A	N/A	15-3/4	(400.1)	7-7/8	(200.0)
		7-3/8	(187.3)		10-1/16	(255.6)	7-3/8	(187.3)	3-11/16	(93.7)	14-3/4	(374.7)	7-3/8	(187.3)

\* Spacing and edge distances shall be divided by 0.75 when anchors are placed in structural lightweight concrete. Linear interpolation may be used for intermediate spacing and edge distances.

### Combined Tension and Shear Loading—for Trubolt Anchors

Allowable loads for anchors subjected to combined shear and tension forces are determined by the following equation:

$$(P_s/P_t)^{5/3} + (V_s/V_t)^{5/3} \leq 1$$

$P_s$  = Applied tension load     $V_s$  = Applied shear load     $P_t$  = Allowable tension load     $V_t$  = Allowable shear load



Call our toll free number 800-848-5611 or visit our web site for the most current product and technical information at [www.itwredhead.com](http://www.itwredhead.com)



# Large Diameter Tapcon (LDT) Anchors

**Finished head, Removable Anchor**

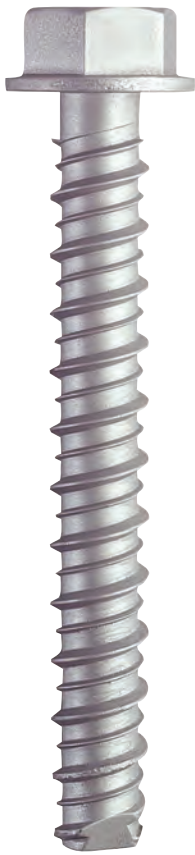

**LDT**

(3/8" & 1/2") (5/8" & 3/4")  
Sawtooth™

**Uses standard drill bits—no special drill bits to purchase or lose!**

## DESCRIPTION/SUGGESTED SPECIFICATIONS

### Self-threading Anchors —

#### SPECIFIED FOR ANCHORAGE INTO CONCRETE



The LDT anchor is a high performance anchor that cuts its own threads into concrete.

Anchor bodies are made of hardened carbon steel and zinc plated, **Grade 5**.

The anchors shall have a finished hex washer head with anti-rotation serrations to prevent anchor back-out. The head of the anchor is stamped with a length identification code for easy inspection.

The hole shall be drilled with carbide tipped hammer drill bits made in accordance to ANSI B212.15-1994.

## ADVANTAGES

### SAVE TIME

#### EASILY INSTALLED

- Installs in less than half the time of wedge anchors or adhesive anchors
- Simply drill a pilot hole and drive the LDT anchor by hand or impact

#### EASILY REMOVED

- No torching or grinding required to remove anchors

### SAVE MONEY

#### LOWER DRILL BIT COSTS

- Use standard ANSI bits instead of proprietary bits
- Single piece design, no nut and washer to assemble

#### USE STANDARD ANSI BITS

- No special proprietary bits to purchase or lose
- Reduce chances for anchor failure due to incorrect bit usage

### Sawtooth Threads™ diameters available on 5/8" and 3/4"

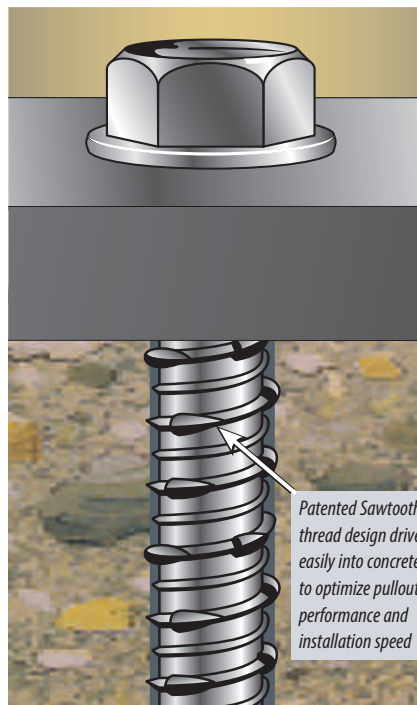

*Patented Sawtooth™ thread design drives easily into concrete to optimize pullout performance and installation speed*

#### IMPROVED PERFORMANCE IN LARGE DIAMETER HOLES

- Superior performance to wedge anchor
- Higher loads in shallow embedments
- Closer edge/spacing distance than mechanical anchors
- More threads for better thread engagement and higher pullout resistance
- Durable induction-hardened tip

#### EASY INSTALLATION

- Easy 2-step installation, simply drill a pilot hole and drive
- Installs in less than half the time of a wedge anchor
- Efficient thread cutting
- Use standard drill bit sizes
- Single piece design—no nut and washer assembly
- Easily removed

## APPLICATIONS

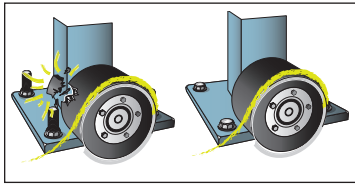

Racking, shelving and conveyors are just a few high volume applications ideal for Large Diameter Tapcon (LDT™). The ease and speed of installation of the LDT can reduce installation time to less than half the time of typical systems used today.

For installation speed, high performance and easy removability, LDT is the anchor of choice.

The LDT's finished head and lack of exposed threads virtually eliminates tire damage on fork lift trucks.

## FEATURES

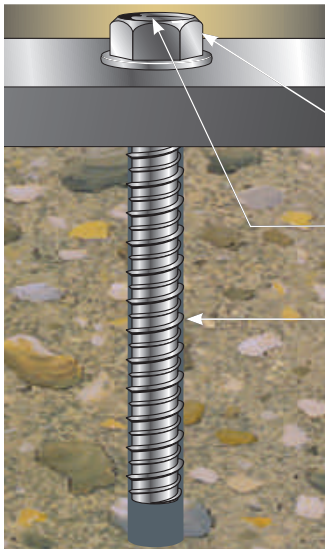

**Easy Installation**  
Installs into concrete by hand or impact wrench

**Anti-rotation Serrated Washer**  
— Prevents anchor back-out

**Extra Large Hex Washer Head**  
— With increased bearing surface

**Length Identification Head Stamp**  
— For embedment inspection after installation

**Hi-Lo Threads**  
— Cuts its own threads into concrete for greater pull-out resistance

## INSTALLATION STEPS

### Installation Steps for Concrete, Lightweight Concrete and Metal Deck

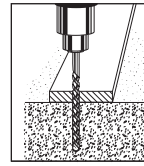

**1.** Using the proper size carbide bit (see chart) drill a pilot hole at least 1" deeper than anchor embedment.

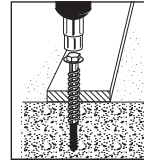

**2.** Using an **electric impact wrench**, or socket wrench (hand install) insert anchor into hole and tighten anchor until fully seated. (see chart for socket size) (do not over tighten).

### Installation Steps for Hollow or Grout-Filled CMU (3/8" and 1/2" diameter)

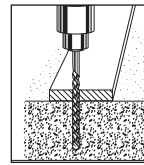

**1.** Using a 5/16" (for 3/8" LDT) or 7/16" (for 1/2" LDT) carbide tipped bit, drill a pilot hole at least 1" deeper than anchor embedment.

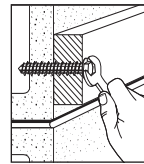

**2.** Using a socket wrench insert anchor into hole and hand tighten anchor until fully seated. (9/16" socket for 3/8" and 3/4" socket for 1/2") (do not over tighten).



### LDT's can be installed with an impact wrench in solid concrete only

Installation by hand—is easy, simply using a socket wrench



Installation by impact wrench—is recommended for faster installations or for high volume projects. Installation with impact wrench—is **not recommended for hollow block.**

## SELECTION CHART

LDT SIZE	ANSI STANDARD DRILL BIT DIAM.	A ANCHOR HEAD (SOCKET SIZE) DIAM.	WASHER DIAM.	B MINIMUM EMBEDMENT	C HOLE DEPTH	USE IN		
						CONCRETE	CMU	
						HOLLOW	GROUT-FILLED	
LDT 3/8"	5/16"	9/16"	13/16"	1-1/2"	2-1/2"	YES	YES	YES
LDT 1/2"	7/16"	3/4"	1"	2-1/2"	3-1/2"	YES	NO	YES
LDT 5/8"	1/2"	13/16"	1-3/16"	2-3/4"	3-3/4"	YES	NO	YES
LDT 3/4"	5/8"	15/16"	1-5/16"	3-1/4"	4-1/4"	YES	NO	YES

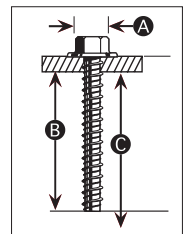

See page 75 for effective lengths and length indication code.



# SELECTION CHART

## LDT Carbon and Stainless Steel

**Carbon Steel with Zinc Plating:** Meets ASTM B695 and B633 specifications for zinc plating of  $\text{Sum} = .0002''$  thickness. This coating is well suited for non-corrosive interior environments.  
**Stainless Steel:** Provides additional corrosion protection for outdoor applications.

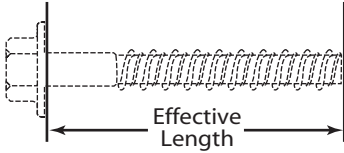

PART NO. CARBON STEEL ZINC PLATED	PART NO. FOR 410 STAINLESS STEEL	ANCHOR DIA.		DRILL BIT DIA.		ANCHOR LENGTH		MAX. THICKNESS OF MATERIAL TO BE FASTENED		QTY/WT PER BOX qty / lbs.	QTY/WT PER MASTER CARTON qty / lbs.
		in.	(mm)	in.	(mm)	in.	(mm)	in.	(mm)		
LDT-3816	—	3/8	(9.5)	5/16	(7.9)	1-3/4	(44.5)	1/4	(6.4)	50 / 3.0	400 / 24.0
LDT-3824	SLDT-3824	3/8	(9.5)	5/16	(7.9)	2-1/2	(63.5)	1	(25.4)	50 / 4.5	400 / 34.0
LDT-3830	SLDT-3830	3/8	(9.5)	5/16	(7.9)	3	(76.2)	1-1/2	(38.1)	50 / 5.0	400 / 40.0
LDT-3840	SLDT-3840	3/8	(9.5)	5/16	(7.9)	4	(101.6)	2-1/2	(63.5)	50 / 6.5	400 / 52.0
LDT-3850	SLDT-3850	3/8	(9.5)	5/16	(7.9)	5	(127.0)	3-1/2	(89.0)	40 / 7.5	320 / 60.0
LDT-1230	SLDT-1230	1/2	(12.7)	7/16	(11.1)	3	(76.2)	1/2	(12.7)	25 / 4.5	150 / 27.0
LDT-1240	SLDT-1240	1/2	(12.7)	7/16	(11.1)	4	(101.6)	1-1/2	(38.1)	25 / 6.0	150 / 36.6
LDT-1250	SLDT-1250	1/2	(12.7)	7/16	(11.1)	5	(127.0)	2-1/2	(63.5)	25 / 7.6	150 / 45.6
LDT-1260	—	1/2	(12.7)	7/16	(11.1)	6	(152.4)	4	(101.6)	20 / 9.0	120 / 54.0
LDT-5830	—	5/8	(15.9)	1/2	(12.7)	3	(76.2)	1/4	(6.4)	10 / 3.5	100 / 35.0
LDT-5840	—	5/8	(15.9)	1/2	(12.7)	4	(101.6)	1-1/4	(31.8)	10 / 4.0	100 / 40.0
LDT-5850	—	5/8	(15.9)	1/2	(12.7)	5	(127.0)	2-1/4	(57.1)	10 / 4.7	100 / 47.0
LDT-5860	—	5/8	(15.9)	1/2	(12.7)	6	(152.4)	3-1/4	(82.6)	10 / 5.4	50 / 27.0
LDT-3444	—	3/4	(19.1)	5/8	(15.9)	4-1/2	(114.3)	1-1/4	(31.8)	10 / 7.4	50 / 37.0
LDT-3454	—	3/4	(19.1)	5/8	(15.9)	5-1/2	(139.7)	2-1/4	(57.1)	10 / 8.1	50 / 40.5
LDT-3462	—	3/4	(19.1)	5/8	(15.9)	6-1/4	(158.8)	3	(76.2)	10 / 9.1	30 / 27.3

\* The stainless steel LDTs will have the number 4 stamped on the head next to the length indication code

## DESIGN GUIDE

For proper selection of anchor diameters based upon pre-drilled holes in base plates and fixtures.

HOLE DIAMETER IN FIXTURE		SUGGESTED LDT DIAMETER	
in.	(mm)	in.	(mm)
7/16	(11.1)	3/8	(9.5)
1/2	(12.7)	3/8	(9.5)
9/16	(14.3)	1/2	(12.7)
5/8	(15.9)	1/2	(12.7)
3/4	(19.1)	5/8	(15.9)
7/8	(22.2)	3/4	(19.1)

## LENGTH INDICATION CODE



Length Code letter located on top of head. Additional number 4 indicates 410 stainless steel

CODE	LENGTH OF ANCHOR	
	in.	(mm)
A	1-1/2 < 2	(38.1 < 50.8)
B	2 < 2-1/2	(50.8 < 63.5)
C	2-1/2 < 3	(63.5 < 76.2)
D	3 < 3-1/2	(76.2 < 88.9)
E	3-1/2 < 4	(88.9 < 101.6)
F	4 < 4-1/2	(101.6 < 114.3)
G	4-1/2 < 5	(114.3 < 127.0)
H	5 < 5-1/2	(127.0 < 139.7)
I	5-1/2 < 6	(139.7 < 152.4)
J	6 < 6-1/2	(152.4 < 165.1)

## PERFORMANCE TABLE

### LDT Anchors

**Ultimate Tension and Shear Values (lbs/kN) in Solid Concrete Carbon and Stainless Steel**

ANCHOR DIAMETER	EMBEDMENT DEPTH	$f'_c = 2000 \text{ PSI (13.8 MPa)}$						$f'_c = 3000 \text{ PSI (20.7 MPa)}$				$f'_c = 4000 \text{ PSI (27.6 MPa)}$			
		TENSION		SHEAR		TENSION		SHEAR		TENSION		SHEAR			
		lbs.	(kN)	lbs.	(kN)	lbs.	(kN)	lbs.	(kN)	lbs.	(kN)	lbs.	(kN)		
3/8	(9.5)	1-1/2	(38.1)	1,336	(5.9)	2,108	(9.4)	1,652	(7.3)	2,764	(12.3)	1,968	(8.8)	3,416	(15.2)
		2	(50.8)	1,492	(6.6)	3,036	(13.5)	2,024	(9.0)	3,228	(14.4)	2,552	(11.4)	3,420	(15.2)
		2-1/2	(63.5)	3,732	(16.6)	3,312	(14.7)	3,748	(16.7)	3,364	(15.0)	3,760	(16.7)	3,424	(15.2)
		3-1/2	(88.9)	5,396	(24.0)	3,312	(14.7)	6,624	(29.5)	3,368	(15.0)	7,852	(34.9)	3,428	(15.2)
1/2	(12.7)	2	(50.8)	3,580	(15.9)	5,644	(25.1)	3,908	(17.4)	6,512	(29.0)	4,236	(18.8)	7,380	(32.8)
		3-1/2	(88.9)	7,252	(32.3)	6,436	(28.6)	8,044	(35.8)	7,288	(32.4)	8,836	(39.3)	8,140	(36.2)
		4-1/2	(114.3)	10,176	(45.3)	7,384	(32.8)	10,332	(46.0)	7,968	(35.4)	10,488	(46.7)	8,552	(38.0)
5/8	(15.9)	2-3/4	(69.9)	5,276	(23.5)	8,656	(38.5)	6,560	(29.2)	11,064	(49.2)	7,844	(34.8)	13,476	(59.9)
		3-1/2	(88.9)	7,972	(35.5)	10,224	(45.5)	9,848	(43.8)	12,144	(54.0)	11,724	(52.2)	14,060	(62.5)
		4-1/2	(114.3)	11,568	(51.5)	12,316	(54.8)	13,432	(59.8)	13,580	(60.4)	16,892	(75.1)	14,840	(66.0)
3/4	(19.1)	3-1/4	(82.6)	6,876	(30.6)	7,140	(31.8)	9,756	(43.4)	10,728	(47.7)	12,636	(56.2)	14,316	(63.6)
		4-1/2	(114.3)	10,304	(45.8)	13,120	(58.4)	14,424	(64.2)	16,868	(75.0)	18,540	(82.5)	20,612	(91.7)
		5-1/2	(139.7)	13,048	(58.0)	17,908	(79.7)	18,156	(80.8)	21,718	(96.9)	23,268	(103.5)	25,652	(114.1)

To calculate the Allowable Load of the anchor, divide the Ultimate Load by 4.

## PERFORMANCE TABLE

### LDT Anchors

**Ultimate Tension and Shear (lbs/kN) in Concrete Block**  
(anchors should be installed by hand in hollow block)

ANCHOR DIAMETER in. (mm)		EMBEDMENT DEPTH in. (mm)		HOLLOW CONCRETE BLOCK				GROUT FILLED CONCRETE BLOCK			
				TENSION lbs. (kN)		SHEAR lbs. (kN)		TENSION lbs. (kN)		SHEAR lbs. (kN)	
3/8	(9.5)	1-1/2	(38.1)	916	(4.1)	3,176	(14.1)	1,592	(7.1)	3,900	(17.3)
1/2	(12.7)	2-1/2	(63.5)	N/A		N/A		5,924	(26.4)	6,680	(29.7)

To calculate the Allowable Load of the anchor, divide the Ultimate Load by 4.

## PERFORMANCE TABLE

### LDT Anchors

**Allowable Tension and Shear (lbs/kN) in Concrete Block**  
(anchors should be installed by hand in hollow block)

ANCHOR DIAMETER in. (mm)		EMBEDMENT DEPTH in. (mm)		HOLLOW CONCRETE BLOCK				GROUT FILLED CONCRETE BLOCK			
				TENSION lbs. (kN)		SHEAR lbs. (kN)		TENSION lbs. (kN)		SHEAR lbs. (kN)	
3/8	(9.5)	1-1/2	(38.1)	229	(1.0)	794	(3.5)	398	(1.8)	975	(4.3)
1/2	(12.7)	2-1/2	(63.5)	N/A		N/A		1,481	(6.6)	1,670	(7.4)

## PERFORMANCE TABLE

### LDT Anchors

**Recommended Edge & Spacing Requirements for Tension Loads\***  
**Carbon and Stainless Steel in Concrete**

ANCHOR DIAMETER		EMBEDMENT DEPTH		EDGE DISTANCE REQUIRED TO OBTAIN MAX. WORKING LOAD		AT MIN. EDGE DISTANCE 1-3/4" (44mm)	SPACING DISTANCE REQUIRED TO OBTAIN MAX. WORKING LOAD		LOAD FACTOR APPLIED AT MIN. SPACING DISTANCE 3" (76mm)
in.	(mm)	in.	(mm)	in.	(mm)		in.	(mm)	
3/8	(9.5)	1-1/2	(38.1)	2	(50.8)	70%	6	(152.4)	44%
		2	(50.8)	2	(50.8)	70%	6	(152.4)	44%
		2-1/2	(63.5)	3	(76.2)	70%	6	(152.4)	44%
		3-1/2	(88.9)	4	(101.6)	70%	6	(152.4)	44%
1/2	(12.7)	2	(50.8)	2-1/4	(57.2)	65%	8	(203.2)	27%
		3-1/2	(88.9)	3	(76.2)	65%	8	(203.2)	27%
		4-1/2	(114.3)	4	(101.6)	65%	8	(203.2)	27%
ANCHOR DIAMETER		EMBEDMENT DEPTH		EDGE DISTANCE REQUIRED TO OBTAIN MAX. WORKING LOAD		AT MIN. EDGE DISTANCE 1-3/4" (44mm)	SPACING DISTANCE REQUIRED TO OBTAIN MAX. WORKING LOAD		LOAD FACTOR APPLIED AT MIN. SPACING DISTANCE 3.75" (95.2mm)
in.	(mm)	in.	(mm)	in.	(mm)		in.	(mm)	
5/8	(15.9)	2-3/4	(69.9)	6-1/4	(158.8)	65%	10	(254)	50%
		3-1/2	(88.9)	6-1/4	(158.8)	65%	10	(254)	50%
		4-1/2	(114.3)	6-1/4	(158.8)	65%	10	(254)	50%
ANCHOR DIAMETER		EMBEDMENT DEPTH		EDGE DISTANCE REQUIRED TO OBTAIN MAX. WORKING LOAD		AT MIN. EDGE DISTANCE 1-3/4" (44mm)	SPACING DISTANCE REQUIRED TO OBTAIN MAX. WORKING LOAD		LOAD FACTOR APPLIED AT MIN. SPACING DISTANCE 4.5" (114.3mm)
in.	(mm)	in.	(mm)	in.	(mm)		in.	(mm)	
3/4	(19.1)	3-1/2	(82.6)	7-1/2	(191)	65%	12	(305)	50%
		4-1/2	(114.3)	7-1/2	(191)	65%	12	(305)	50%
		5-1/2	(139.7)	7-1/2	(191)	65%	12	(305)	50%

\* Edge and spacing distance shall be divided by .75 when anchors are placed in structural lightweight concrete. Linear interpolation may be used for intermediate spacing and edge distances.

For 5/8" and 3/4" LDT Anchors, the critical edge distance for these anchors is 10 times the anchor diameter. The edge distance of these anchors may be reduced to 1-3/4" provided a 0.65 load factor is used for tension loads, a 0.15 load factor is used for shear loads applied perpendicular to the edge, or a 0.60 load factor is used for shear loads applied parallel to the edge. Linear interpolation may be used for intermediate edge distances.



Call our toll free number 800-848-5611 or visit our web site for the most current product and technical information at [www.itwredhead.com](http://www.itwredhead.com)



# PERFORMANCE TABLE

## LDT Anchors

### Recommended Edge & Spacing Requirements for Shear Loads\* Carbon and Stainless Steel in Concrete

ANCHOR DIAMETER		EMBEDMENT DEPTH		EDGE DISTANCE REQUIRED TO OBTAIN MAX. WORKING LOAD		AT MIN. EDGE DISTANCE 1-3/4" (44mm)	SPACING DISTANCE REQUIRED TO OBTAIN MAX. WORKING LOAD		LOAD FACTOR APPLIED AT MIN. SPACING DISTANCE 3" (76mm)
in.	(mm)	in.	(mm)	in.	(mm)		in.	(mm)	
3/8	(9.5)	1-1/2	(38.1)	3	(76.2)	25%	6	(152.4)	57%
		2	(50.8)	4	(101.6)	25%	6	(152.4)	57%
		2-1/2	(63.5)	5	(127.0)	25%	6	(152.4)	57%
		3-1/2	(88.9)	5	(127.0)	25%	6	(152.4)	57%
1/2	(12.7)	2	(50.8)	5	(127.0)	25%	8	(203.2)	60%
		3-1/2	(88.9)	5	(127.0)	25%	8	(203.2)	60%
		4-1/2	(114.3)	5-1/2	(139.7)	25%	8	(203.2)	60%
5/8	(15.9)	2-3/4	(69.9)	6-1/4	(158.8)	15%**/60%***	10	(254)	75%
		3-1/2	(88.9)	6-1/4	(158.8)	15%**/60%***	10	(254)	75%
		4-1/2	(114.3)	6-1/4	(158.8)	15%**/60%***	10	(254)	75%
3/4	(19.1)	3-1/2	(82.6)	7-1/2	(191)	15%**/60%***	12	(305)	75%
		4-1/2	(114.3)	7-1/2	(191)	15%**/60%***	12	(305)	75%
		5-1/2	(139.7)	7-1/2	(191)	15%**/60%***	12	(305)	75%

\* Edge and spacing distances shall be divided by .75 when anchors are placed in structural lightweight concrete. Linear interpolation may be used for intermediate spacing and edge distances.

\*\* 15% = shear load applied perpendicular to the edge

\*\*\* 60% = shear load applied parallel to the edge

# PERFORMANCE TABLE

## LDT Anchors

### Anchoring Overhead in 3,000 PSI Lightweight Concrete on Metal Deck

ANCHOR	DRILL HOLE DIAMETER		EMBEDMENT		3000PSI (20.7 MPa) CONCRETE				
	in.	(mm)	lbs.	(kN)	ULTIMATE TENSION LOAD			ALLOWABLE WORKING LOAD	
						lbs.	(kN)	lbs.	(kN)
3/8" LDT	5/16	(7.9)	1-1/2	(38.1)	Upper Flute	2,889	(12.9)	722	(3.2)
					Lower Flute	1,862	(8.3)	465	(2.1)

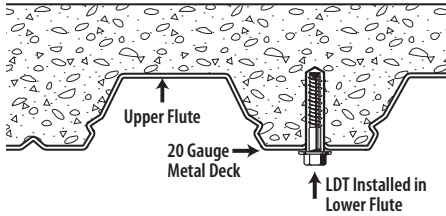

**For use in concrete and concrete block**

<b>1/2" LDT</b>	<b>1/2" adhesive</b>	<b>5/8" wedge</b>
INSTALLS IN 1/2 THE TIME	DIFFICULT TO REMOVE	PERMANENT APPLICATION
EASILY REMOVED	EXPOSED THREADS	EXPOSED THREADS
FINISHED HEAD	5-STEP INSTALLATION	DIFFICULT TO REMOVE
	CURE TIME	

**DRILL BIT SIZE REQUIRED**

LDT anchors specify a smaller & less expensive drill bit than those required with the 1/2" adhesive threaded rod or the 5/8" wedge.

7/16" DRILL BIT

9/16" DRILL BIT

5/8" DRILL BIT

4-1/2"

4-1/2"

7"

**HOLE DEPTH REQUIRED**

At 4-1/2" embedment the LDT anchor will give you performance (2000 PSI concrete) similar to 1/2" adhesive anchor of the same depth or 5/8" wedge anchors at 7" deep. (2000 PSI concrete)

**RED HEAD**  
 Call our toll free number 800-848-5611 or visit our web site for the most current product and technical information at [www.itwredhead.com](http://www.itwredhead.com)

**RED HEAD** 69

# Multi-Set II<sup>®</sup> Drop-In Anchors

## Internally Threaded Heavy- Duty Anchoring Systems

### DESCRIPTION/SUGGESTED SPECIFICATIONS

#### Drop-In, Shell-Type Anchors—

#### SPECIFIED FOR ANCHORAGE INTO CONCRETE

Drop-In, shell-type anchors feature an internally threaded, all-steel shell with expansion cone insert and flush embedment lip. Anchors are manufactured from zinc-plated carbon steel, 18-8 stainless steel and 316 stainless steel.

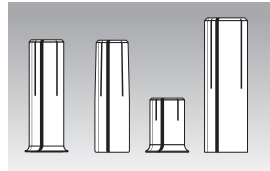

Multi-Set II Drop-In Anchors

Anchors should be installed with carbide tipped hammer drill bits made in accordance to ANSI B212.15-1994 specifications.

The minimum concrete thickness for an anchor is 1-1/2 times the embedment depth – or the embedment depth plus three times the anchor diameter – whichever is greater.

Anchors should be tested to ASTM E488 criteria.

### ADVANTAGES

#### Short Drop-In (RX) Anchors

Ideal for Hollow-Core, Pre-Cast Plank and Post Tension Slabs



- Optimized for use in hollow-core, pre-cast plank and post-tension slabs
- Lip keeps anchor flush during installation
- Shallow drilling—fast installation



RX Drop-In Anchor



#### RM Drop-In Anchor



- Lipped anchor body keeps anchor flush
- Easy installation
- Keeps all rods same length
- Easy inspection
- Available in carbon steel and 18-8 stainless steel

#### RL Drop-In Anchor



- Below surface setting for easy patch work

#### Coil Thread Anchor



- Quick thread attachment—ideal for 1 sided forming
- Use coil rod on job
- Available in 1/2" diameter



## APPLICATIONS



Pumps and heavy piping are common applications for larger diameter Multi-Set Drop-In Anchors.

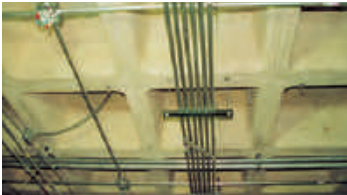

Cable tray and strut suspended from concrete ceilings are ideal Multi-Set applications. In post-tension or hollow-core slabs use the RX-38.



The Multi-Set Anchor is the standard for pipe-hanging. The RM version has a retainer lip to keep all anchors flush at the surface, keeping all your threaded rod the same length.

## FEATURES

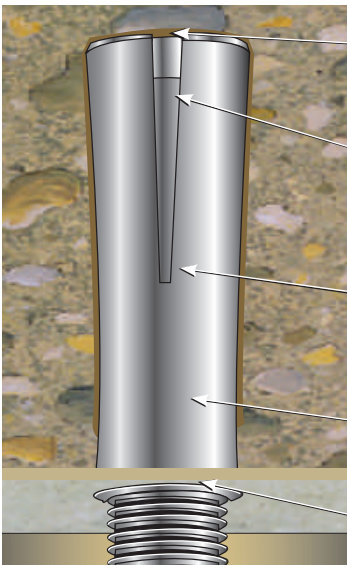

**Expander Slots**—allow for easy setting and superior performance

**Cone Insert**—that expands the anchor when driven with setting tool and hammer

**Body**—available in zinc-plated steel, 18-8 stainless steel, and 316 stainless steel

**Easy Depth Inspection**—keeps threaded rod drop lengths consistent

**Retainer Lip**—to keep anchor flush with surface

For use with threaded rods or headed bolts (supplied by contractor)

## APPROVALS/LISTINGS

Meets or exceeds U.S. Government G.S.A. Specification A-A-55614 Type 1 (Formerly GSA: FF-S-325 Group VIII)

Multi-Set II Drop-in anchors may be covered by one or more of the following approvals/listings:

- Underwriters Laboratories
- Factory Mutual
- Caltrans

See Selection Chart next page.

## INSTALLATION STEPS

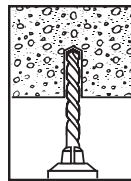

*To set anchor flush with surface:*

1. Drill hole to required embedment (see Table on page 82).

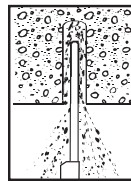

2. Clean hole with pressurized air.



3. Drive anchor flush with surface of concrete.

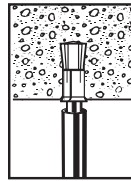

4. Expand anchor with setting tool provided (see chart on page 82). Anchor is properly expanded when shoulder of setting tool is flush with top of anchor.

## SELECTION CHART

### Bits for RX-38 and RX-12 Short Drop-Ins

BIT NO.	DESCRIPTION	DRILLING DEPTH
DCX-138	3/8" Depth Charge Stop Drill (RX-38)	3/4"
DCX-112	1/2" Depth Charge Stop Drill (RX-12)	1"



- Shoulder prevents over drilling. Less likely to hit reinforcing steel or post-tension cable in concrete



- No wasted time or energy drilling deeper than necessary
- Prevents anchor from dropping too far into hole below work surface



Call our toll free number 800-848-5611 or visit our web site for the most current product and technical information at [www.itwredhead.com](http://www.itwredhead.com)



## SELECTION CHARTS





# Multi-Set II Drop-In Anchors



**PART NUMBER RTX-138**  
For use with RX-38 only.



**PART NUMBER RTX-112**  
For use with RX-12 only.

USER TYPE / APPLICATION	BASE MATERIAL	DROP-IN ANCHOR TYPE	APPROVALS	PART NO.	SETTING TOOL PART NO.*	BOLT SIZE/ THREADS PER INCH	DRILL BIT DIAM.		THREAD DEPTH		EMBEDMENT MIN. HOLE DEPTH***		QTY/WT PER BOX qty / lbs.	QTY/ WT PER MASTER CARTON qty / lbs.
							in.	(mm)	in.	(mm)	in.	(mm)		
HVAC/Fire Sprinkler Plumber (Pipe-fitter)	Solid concrete/ lightweight fill deck	RM 	UL, FM	RM-38	RT-138	3/8" / 16	1/2	(12.7)	1/2	(12.7)	1-5/8	(41.3)	50 / 3.4	500 / 36
			UL, FM Caltrans	RM-12	RT-112	1/2" / 13	5/8	(15.9)	3/4	(19.1)	2	(50.8)	50 / 5.8	400 / 49
			UL, FM	RM-58	RT-158	5/8" / 11	7/8	(22.2)	1	(25.4)	2-1/2	(63.5)	25 / 7.8	125 / 41
			UL, FM Caltrans	RM-34	RT-134	3/4" / 10	1	(25.4)	1-1/4	(31.8)	3-3/16	(81.0)	25 / 11.9	100 / 49
	Hollow-core pre-cast or Post tension	RX 	FM	RX-38	RTX-138	3/8" / 16	1/2	(12.7)	3/8	(9.5)	3/4	(19.1)	100 / 3.5	1000 / 36
			N/A	RX-12	RTX-112	1/2" / 13	5/8	(15.9)	1/2	(12.7)	1	(25.4)	50 / 3.0	500 / 31
	Solid concrete/ lightweight fill deck	SRM** 18-8 S.S. 	N/A	SRM-14	RT-114	1/4" / 20	3/8	(9.5)	3/8	(9.5)	1	(25.4)	100 / 2.7	1000 / 28
			UL, FM	SRM-38	RT-138	3/8" / 16	1/2	(12.7)	1/2	(12.7)	1-5/8	(41.3)	50 / 3.4	500 / 36
UL, FM			SRM-12	RT-112	1/2" / 13	5/8	(15.9)	3/4	(19.1)	2	(50.8)	50 / 6.0	400 / 50	
N/A			SRM-34	RT-134	3/4" / 10	1	(25.4)	1-1/4	(31.8)	3-3/16	(81.0)	25 / 12.0	100 / 50	
Concrete Contractor, General Contractor	Solid concrete	CL Coil Threaded 	N/A	CL-12	RT-112	1/2" / 6	5/8	(15.9)	3/4	(19.1)	2	(50.8)	50 / 5.7	400 / 47
Concrete Cutting/Sawing Contractor/Misc. Metal	Solid concrete/ lightweight fill deck	RL (w/o lip) 	N/A	RL-14	RT-114	1/4" / 20	3/8	(9.5)	3/8	(9.5)	1	(25.4)	100 / 2.6	1000 / 28
			N/A	RL-38	RT-138	3/8" / 16	1/2	(12.7)	1/2	(12.7)	1-5/8	(41.3)	50 / 3.4	500 / 36
			N/A	RL-12	RT-112	1/2" / 13	5/8	(15.9)	3/4	(19.1)	2	(50.8)	50 / 5.8	400 / 49
			N/A	RL-58	RT-158	5/8" / 11	7/8	(22.2)	1	(25.4)	2-1/2	(63.5)	25 / 7.8	125 / 41
			N/A	RL-34	RT-134	3/4" / 10	1	(25.4)	1-1/4	(31.8)	3-3/16	(81.0)	25 / 11.9	100 / 49

\* 1 setting tool per master carton. \*\* For continuous extreme low temperature, use stainless steel. \*\*\* Embedment is equal to overall length of Drop-In Anchor

## RX-38 and RX-12 Short Drop-In Kits

PART NO.	DESCRIPTION	PART NO.	DESCRIPTION
RX-38	3/8" drop-in	RX-12	1/2" drop-in
RTX-138	Setting Tool for RX-38	RTX-112	Setting Tool for RX-12
DCX-138	Depth Charge Stop Drill – 1/2"	DCX-112	Depth Charge Stop Drill – 5/8"

## PERFORMANCE TABLE

### Multi-Set II Drop-In Anchors

### Ultimate Tension and Shear Values (lbs/kN) in Solid Concrete\*

BOLT DIAM.		DRILL BIT SIZE		MIN. EMBEDMENT DEPTH		ANCHOR TYPE	TENSION lbs. (kN)						SHEAR lbs. (kN)	
in.	(mm)	in.	(mm)	in.	(mm)		f <sub>c</sub> = 2000 PSI	(13.8 MPa)	f <sub>c</sub> = 4000 PSI	(27.6 MPa)	f <sub>c</sub> = 6000 PSI	(41.4 MPa)	f <sub>c</sub> ≥ 2000 PSI	(13.8 MPa)
1/4	(6.4)	3/8	(9.5)	1	(25.4)	RM, RL or CL-Carbon or SRM-18-8 S.S. or SSRM 316 S.S.	1,680	(7.5)	2,360	(10.5)	2,980	(13.3)	1,080	(4.8)
3/8	(9.5)	1/2	(12.7)	1-5/8	(41.3)		2,980	(13.3)	3,800	(16.9)	6,240	(27.8)	3,160	(14.1)
1/2	(12.7)	5/8	(15.9)	2	(50.8)		3,300	(14.7)	5,840	(26.0)	8,300	(36.9)	4,580	(20.4)
5/8	(15.9)	7/8	(22.2)	2-1/2	(63.5)		5,500	(24.5)	8,640	(38.4)	11,020	(49.0)	7,440	(33.1)
3/4	(19.1)	1	(25.4)	3-3/16	(81.0)		8,280	(36.8)	9,480	(42.2)	12,260	(54.5)	10,480	(46.6)

\* To calculate the Allowable Load of the anchor, divide the Ultimate Load by 4.

\* For continuous extreme low temperature applications, use stainless steel.

## PERFORMANCE TABLE

### Multi-Set II Drop-In Anchors

### Ultimate Tension and Shear Values (lbs/kN) in Lightweight Concrete\*

BOLT DIAMETER		DRILL BIT SIZE		MINIMUM EMBEDMENT DEPTH		ANCHOR TYPE	LIGHTWEIGHT CONCRETE f <sub>c</sub> = 3000 PSI (20.7 MPa)				LOWER FLUTE OF STEEL DECK WITH LIGHTWEIGHT CONCRETE FILL f <sub>c</sub> = 3000 PSI (20.7 MPa)			
in.	(mm)	in.	(mm)	in.	(mm)		TENSION		SHEAR		TENSION		SHEAR	
						lbs.		(kN)		lbs.		(kN)		
3/8	(9.5)	1/2	(12.7)	1-5/8	(39.7)	RM, RL or CL-Carbon or SRM-18-8 S.S. or SSRM-316 S.S.	2,035	(9.1)	1,895	(8.4)	3,340	(14.9)	4,420	(19.6)
1/2	(12.7)	5/8	(15.9)	2	(50.8)		2,740	(12.2)	2,750	(12.2)	3,200	(14.2)	4,940	(22.0)
5/8	(15.9)	7/8	(22.2)	2-1/2	(63.5)		4,240	(18.9)	4,465	(19.9)	5,960	(26.5)	5,840	(26.0)
3/4	(19.1)	1	(25.4)	3-3/16	(81.0)		5,330	(23.7)	6,290	(28.0)	8,180	(36.4)	9,120	(40.6)

\* To calculate the Allowable Load of the anchor, divide the Ultimate Load by 4.

## PERFORMANCE TABLE

### Multi-Set II Drop-In Anchors

### Recommended Edge and Spacing Distance Requirements\*

BOLT DIAMETER		DRILL BIT SIZE		EMBEDMENT DEPTH		ANCHOR TYPE	EDGE DISTANCE REQUIRED TO OBTAIN MAX. WORKING LOAD		MIN. EDGE DISTANCE AT WHICH LOAD FACTOR APPLIED = .80 FOR TENSION = .70 FOR SHEAR		SPACING REQUIRED TO OBTAIN MAX. WORKING LOAD		MIN. ALLOWABLE SPACING BETWEEN ANCHORS LOAD FACTOR APPLIED = .80 FOR TENSION = .55 FOR SHEAR	
in.	(mm)	in.	(mm)	in.	(mm)		in.	(mm)	in.	(mm)	in.	(mm)	in.	(mm)
1/4	(6.4)	3/8	(9.5)	1	(25.4)	RM, RL or CL-Carbon or SRM-18-8 S.S. or SSRM-316 S.S.	1-3/4	(44.5)	7/8	(22.2)	3-1/2	(88.9)	1-3/4	(44.5)
3/8	(9.5)	1/2	(12.7)	1-5/8	(41.3)		2-7/8	(73.0)	1-7/16	(36.5)	5-11/16	(144.5)	2-7/8	(73.0)
1/2	(12.7)	5/8	(15.9)	2	(50.8)		3-1/2	(88.9)	1-3/4	(44.5)	7	(177.8)	3-1/2	(88.9)
5/8	(15.9)	7/8	(22.2)	2-1/2	(63.5)		4-3/8	(111.1)	2-3/16	(55.6)	8-3/4	(222.3)	4-3/8	(111.1)
3/4	(19.1)	1	(25.4)	3-3/16	(81.0)		5-5/8	(142.9)	2-13/16	(71.4)	11-3/16	(284.2)	5-5/8	(142.9)

\* The minimum concrete thickness for a Drop-In is 1-1/2 times the embedment depth - OR - the embedment depth plus three times the anchor diameter - whichever is greater.

\* Spacing and edge distances shall be divided by 0.75 when anchors are placed in structural lightweight concrete. Linear interpolation may be used for intermediate spacing and edge distances.



Call our toll free number 800-848-5611 or visit our web site for the most current product and technical information at [www.itwredhead.com](http://www.itwredhead.com)



## PERFORMANCE TABLE

### Multi-Set II Drop-In Anchors

### Ultimate Tension and Shear Values (lbs/kN) for RX-series (3/4" and 1" Embedment)\*

BOLT DIAMETER in.   (mm)		DRILL BIT SIZE in.   (mm)		EMBEDMENT in.   (mm)		2500 PSI (17.2 MPa) CONCRETE				4000 PSI (27.6 MPa) CONCRETE				HOLLOW CORE			
						TENSION lbs.   (kN)		SHEAR lbs.   (kN)		TENSION lbs.   (kN)		SHEAR lbs.   (kN)		TENSION lbs.   (kN)		SHEAR lbs.   (kN)	
3/8	(9.5)	1/2	(12.7)	3/4	(19.1)	1,571	(7.0)	2,295	(10.2)	1,987	(8.8)	2,903	(12.9)	1,908	(8.5)	2,401	(10.7)
1/2	(12.7)	5/8	(15.9)	1	(25.4)	2,113	(9.4)	2,585	(11.5)	2,673	(11.9)	3,270	(14.5)	2,462	(11.0)	2,401	(10.7)

\* The tabulated values are for RX anchors installed at a minimum of 12 diameters on center and minimum edge distance of 6 diameters for 100 percent anchor efficiency. Spacing and edge distance may be reduced to 6 diameters spacing and 3 diameter edge distance provided the values are reduced 50 percent. Linear Interpolation may be used for intermediate spacings and edge margins.

\* To calculate the Allowable Load of the anchor, divide the Ultimate Load by 4

## PERFORMANCE TABLE

### Multi-Set II Drop-In Anchors

### Anchoring Overhead in 3,000 PSI Lightweight Concrete on Metal Deck\*

ANCHOR	DRILL HOLE DIAMETER		EMBEDMENT		3000 PSI (20.7 MPa) CONCRETE				
	in.	(mm)	in.	(mm)	ULTIMATE TENSION LOAD		ALLOWABLE WORKING LOAD		
					lbs.	(kN)	lbs.	(kN)	
RX-38 Drop-In	1/2	(12.7)	3/4	(19.1)	Upper Flute	1,410	(6.3)	353	(1.6)
					Lower Flute	1,206	(5.4)	301	(1.3)

\* To calculate the Allowable Load of the anchor, divide the Ultimate Load by 4

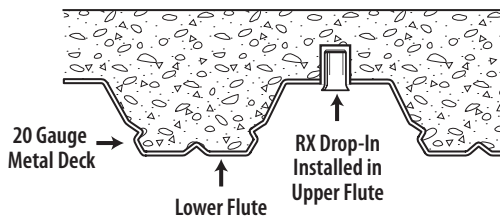

## Combined Tension and Shear Loading—for Multi-Set Anchors

Allowable loads for anchors subjected to combined shear and tension forces are determined by the following equation:

$$(P_s/P_t)^{5/3} + (V_s/V_t)^{5/3} \leq 1$$

$P_s$  = Applied tension load

$V_s$  = Applied shear load

$P_t$  = Allowable tension load

$V_t$  = Allowable shear load

# Dynabolt<sup>®</sup> Sleeve Anchors

**Versatile,  
Medium-Duty  
Sleeve Anchor**



**Dynabolt  
Hex Nut Sleeve Anchor**

## APPROVALS/LISTINGS

Meets or exceeds U.S. Government G.S.A. Specification A-A-1922A (Formerly GSA: FF-S-325 Group II, Type 3, Class 3)

Factory Mutual

## DESCRIPTION/SUGGESTED SPECIFICATIONS

### Sleeve Type Anchors—

**SPECIFIED FOR ANCHORAGE INTO CONCRETE, GROUT-FILLED CONCRETE BLOCK, HOLLOW CONCRETE BLOCK AND BRICK**



**Dynabolt  
Masonry  
Sleeve  
Anchor**

Sleeve type anchors feature a split expansion sleeve over a threaded stud bolt body and integral expander, nut and washer.

Anchors are made of Plated Carbon Steel, or Type 304 Stainless Steel.

Anchors should be installed with carbide tipped hammer drill bits made in accordance to ANSI B212.15-1994.

Anchors are tested to ASTM E488 criteria.

## ADVANTAGES

- Anchor diameter equals hole diameter
- Available in hex head and three other head styles
- Available 3/8 - 3/4" diameter up to 5" length
- Zinc plated carbon steel and 304 stainless steel
- Provides full 360° hole contact over large area and reduces concrete stress
- Heavy-loading capacity
- Preassembled for faster, easier installations
- Dynabolt can be installed through object to be fastened
- Sleeve design improves holding power
- No pre-spotting of holes necessary

### Available Head Styles

Full range of head style, corrosion protection, and sizes makes the Dynabolt Sleeve the right product for almost any application.

Phillips Flat Head  
(FS)

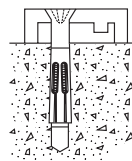

Hex Nut  
(HN)

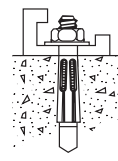

## INSTALLATION STEPS

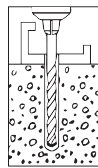

**1.** Use a carbide tipped drill bit whose diameter is equal to the anchor. See Chart to determine proper size bit for anchor used. Drill hole to any depth exceeding minimum embedment. Clean hole.

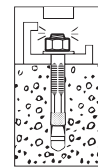

**2.** Insert assembled anchor through fixture and into hole so that washer or head is flush with materials to be fastened.

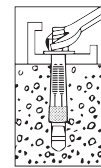

**3.** Expand anchor by tightening nut 2 to 3 full turns past the hand tight position, or the specified torque requirement.

## APPLICATIONS



Electrical junction boxes are common applications for the Dynabolt Sleeve anchor because it works well in solid concrete, concrete block, and brick. It is also available in several finished head styles.



The Dynabolt Sleeve anchor works well in hollow materials like brick and block. It is available in zinc-plated carbon steel and 304 stainless steel.



## SELECTION CHART

# Dynabolt

Carbon Steel w/Zinc Plating

HEAD STYLE	PART NO.	ANCHOR DIA. & DRILL BIT SIZE	EFFECTIVE ANCHOR LENGTH*		BOLT DIA. / THREADS PER INCH	MIN. EMBEDMENT		MAX. THICKNESS OF MATERIAL TO BE FASTENED		QTY/WT PER BOX qty / lbs.	QTY/WT PER MASTER CTN qty / lbs.
			in.	(mm)		in.	(mm)	in.	(mm)		
Phillips Flat Head	HN-3817	3/8"	1-7/8	(47.6)	5/16" / 18	1-1/2	(38.1)	3/8	(9.5)	50 / 3.5	500 / 36
	HN-3830		3	(76.2)	5/16" / 18	1-1/2	(38.1)	1-1/2	(38.1)	50 / 4.9	400 / 40
	HN-1222	1/2"	2-1/4	(57.2)	3/8" / 16	1-7/8	(47.6)	3/8	(9.5)	25 / 3.3	250 / 34
	HN-1230		3	(76.2)	3/8" / 16	1-7/8	(47.6)	1-1/8	(28.6)	25 / 4.0	200 / 33
	HN-1240		4	(101.6)	3/8" / 16	1-7/8	(47.6)	2-1/8	(54.0)	25 / 5.3	200 / 44
	HN-5842		5/8"	4-1/4	(108.0)	1/2" / 13	2	(50.8)	2-1/4	(57.2)	10 / 3.9
Phillips Flat Head	FS-3840	3/8"	4	(101.6)	5/16" / 18	1-1/2	(38.1)	2-1/2	(63.5)	50 / 5.3	400 / 44
	FS-3850	(head dia. .722)	5	(127.0)	5/16" / 18	1-1/2	(38.1)	3-1/2	(88.9)	50 / 5.6	300 / 40

Phillips flat head uses a standard 80°–82° counter sink.



**Typical Applications**—Shelf ledgers, electrical boxes, conduit  
**Environment**—Interior (non-corrosive)  
**Level of Corrosion**—Low

### \*Effective Anchor Length

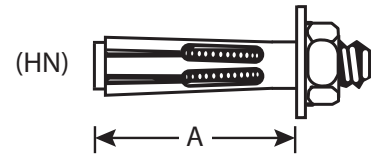
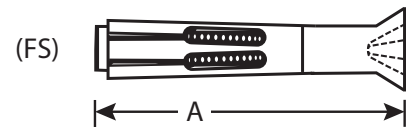

## SELECTION CHART

# Dynabolt

304 Stainless Steel

HEAD STYLE	PART NO.	ANCHOR DIA. & DRILL BIT SIZE	EFFECTIVE ANCHOR LENGTH		BOLT DIA. / THREADS PER INCH	MIN. EMBEDMENT		MAX. THICKNESS OF MATERIAL TO BE FASTENED		QTY/WT PER BOX qty / lbs.	QTY/WT PER MASTER CTN qty / lbs.
			in.	(mm)		in.	(mm)	in.	(mm)		
Phillips Flat Head	SFS-3840	3/8"	4	(101.6)	5/16" / 18	1-1/2	(38.1)	2-1/2	(63.5)	50 / 5.3	400 / 44

Flat head uses a standard 80°–82° counter sink.

For continuous extreme low temperature applications, use stainless steel.



**Typical Applications**—Cladding and Brick Ties  
**Environment**—Slight to moderate degree of pollution  
**Level of Corrosion**—Medium

## PERFORMANCE TABLE

### Dynabolt Sleeve Anchors

### Ultimate Tension and Shear Values in Solid Concrete (lbs/kN)\*

ANCHOR DIAMETER in.   (mm)		INSTALLATION TORQUE ft. lbs.   (Nm)		BOLT DIAMETER in.   (mm)		MINIMUM EMBEDMENT DEPTH in.   (mm)		ANCHOR TYPE (STEEL)	f'c = 2000 PSI (13.8 MPa)				f'c = 3000 PSI (20.7 MPa)				f'c = 4000 PSI (27.6 MPa)			
									TENSION lbs.   (kN)		SHEAR lbs.   (kN)		TENSION lbs.   (kN)		SHEAR lbs.   (kN)		TENSION lbs.   (kN)		SHEAR lbs.   (kN)	
1/4	(6.4)	3.5	(4.7)	3/16	(4.8)	1-1/8	(28.6)	Carbon or Stainless	1,200	(5.3)	1,215	(5.4)	1,325	(5.9)	1,215	(5.4)	1,450	(6.4)	1,215	(5.4)
5/16	(7.9)	8	(10.8)	1/4	(6.4)	1-1/4	(31.8)		1,400	(6.2)	2,040	(9.1)	1,920	(8.5)	2,220	(9.9)	2,600	(11.6)	2,400	(10.7)
3/8	(9.5)	14	(19.0)	5/16	(7.9)	1-1/2	(38.1)		1,620	(7.2)	2,560	(11.4)	2,240	(10.0)	2,800	(12.5)	3,100	(13.8)	3,040	(13.5)
1/2	(12.7)	20	(27.1)	3/8	(9.5)	1-7/8	(47.6)		2,220	(9.9)	3,250	(14.5)	3,140	(14.0)	4,000	(17.8)	4,400	(19.6)	4,500	(20.0)
5/8	(15.9)	48	(65.1)	1/2	(12.7)	2	(50.8)		3,080	(13.7)	6,440	(28.6)	4,400	(19.6)	7,240	(32.2)	6,120	(27.2)	8,080	(35.9)
3/4	(19.1)	90	(122.0)	5/8	(15.9)	2-1/4	(57.2)		4,200	(18.7)	10,200	(45.4)	6,060	(27.0)	11,600	(51.6)	8,900	(39.6)	13,100	(58.3)

\* For continuous extreme low temperature applications, use stainless steel.

\* To calculate the Allowable Load of the anchor, divide the Ultimate Load by 4.

## PERFORMANCE TABLE

### Dynabolt Sleeve Anchors

### Ultimate Tension and Shear Values in Lightweight Concrete (lbs/kN)\*

ANCHOR DIAMETER in.   (mm)		INSTALLATION TORQUE ft. lbs.   (Nm)		BOLT DIAMETER in.   (mm)		MINIMUM EMBEDMENT DEPTH in.   (mm)		ANCHOR TYPE (STEEL)	f'c = 4000 PSI (27.6 MPa)				f'c = 6000 PSI (41.4 MPa)			
									TENSION lbs.   (kN)		SHEAR lbs.   (kN)		TENSION lbs.   (kN)		SHEAR lbs.   (kN)	
1/4	(6.4)	3.5	(4.7)	3/16	(4.8)	1-1/8	(28.6)	Carbon or Stainless	870	(3.9)	730	(3.2)	1,066	(4.7)	894	(4.0)
5/16	(7.9)	8	(10.8)	1/4	(6.4)	1-1/4	(31.8)		1,260	(5.6)	1,680	(7.5)	1,440	(6.4)	2,220	(9.9)
3/8	(9.5)	14	(19.0)	5/16	(7.9)	1-1/2	(38.1)		1,620	(7.2)	2,300	(10.2)	2,240	(10.0)	2,800	(12.5)
1/2	(12.7)	25	(33.9)	3/8	(9.5)	1-7/8	(47.6)		2,600	(11.6)	2,400	(10.7)	3,160	(14.1)	2,400	(10.7)
5/8	(15.9)	48	(65.1)	1/2	(12.7)	2	(50.8)		3,240	(14.4)	5,600	(24.9)	4,300	(19.1)	7,840	(34.9)
3/4	(19.1)	90	(122.0)	5/8	(15.9)	2-1/4	(57.2)		3,640	(16.2)	8,640	(38.4)	5,800	(25.8)	12,480	(55.5)

\* To calculate the Allowable Load of the anchor, divide the Ultimate Load by 4.

## PERFORMANCE TABLE

### Dynabolt Sleeve Anchors

### Ultimate Tension and Shear Values in Concrete Masonry Units (lbs/kN)\*

ANCHOR DIAMETER in.   (mm)		INSTALLATION TORQUE ft. lbs.   (Nm)		BOLT DIAMETER in.   (mm)		MINIMUM EMBEDMENT DEPTH in.   (mm)		ANCHOR TYPE (STEEL)	LIGHTWEIGHT								MEDIUM WEIGHT							
									HOLLOW CORE				GROUT FILLED				HOLLOW CORE				GROUT FILLED			
									TENSION lbs.   (kN)		SHEAR lbs.   (kN)		TENSION lbs.   (kN)		SHEAR lbs.   (kN)		TENSION lbs.   (kN)		SHEAR lbs.   (kN)		TENSION lbs.   (kN)		SHEAR lbs.   (kN)	
1/4	(6.4)	3.5	(4.7)	3/16	(4.8)	1-1/8	(28.6)	Carbon	1,120	(5.0)	1,215	(5.4)	1,120	(5.0)	1,215	(5.4)	1,120	(5.0)	1,215	(5.4)	1,120	(5.0)	1,215	(5.4)
									Stainless	640	(2.8)	1,620	(7.2)	640	(2.8)	1,620	(7.2)	640	(2.8)	1,620	(7.2)	640	(2.8)	1,620
3/8	(9.5)	15	(20.3)	5/16	(7.9)	1-1/2	(38.1)	Carbon	1,360	(6.0)	2,560	(11.4)	1,360	(6.0)	2,560	(11.4)	1,360	(6.0)	2,560	(11.4)	1,360	(6.0)	2,560	(11.4)
									Stainless	1,160	(5.2)	2,560	(11.4)	1,160	(5.2)	2,560	(11.4)	1,160	(5.2)	2,560	(11.4)	1,160	(5.2)	2,560
1/2	(12.7)	25	(33.9)	3/8	(9.5)	1-7/8	(47.6)	Carbon	N/A		N/A		2,200	(9.9)	3,500	(15.6)	N/A		N/A		2,200	(9.9)	3,500	(15.6)
									Stainless	N/A		N/A		2,100	(9.3)	3,500	(15.6)	N/A		N/A		2,100	(9.3)	3,500
5/8	(15.9)	55	(74.6)	1/2	(12.7)	2	(50.8)	Carbon	N/A		N/A		3,080	(13.7)	6,440	(28.6)	N/A		N/A		3,080	(13.7)	6,440	(28.6)
									Stainless	N/A		N/A		3,080	(13.7)	6,440	(28.6)	N/A		N/A		2,820	(12.5)	6,440
3/4	(19.1)	90	(122.0)	5/8	(15.9)	2-1/2	(63.5)	Carbon	N/A		N/A		4,200	(18.7)	10,200	(45.4)	N/A		N/A		4,200	(18.7)	10,200	(45.4)

\* To calculate the Allowable Load of the anchor, divide the Ultimate Load by 4. The tabulated values are for anchors installed in a minimum of 12 diameters on center and a minimum edge distance of 6 diameters for 100 percent anchor efficiency. Spacing and edge distance may be reduced to 6 diameter spacing and 3 diameter edge distance, provided the values are reduced 50 percent. Linear interpolation may be used for intermediate spacings and edge distances.

Note: N/A is defined as Not Advisable.

### Combined Tension and Shear Loading—for Dynabolt Anchors

Allowable loads for anchors subjected to combined shear and tension forces are determined by the following equation:

$$(Ps/Pt) + (Vs/Vt) \leq 1$$

Ps = Applied tension load

Vs = Applied shear load

Pt = Allowable tension load

Vt = Allowable shear load



Call our toll free number 800-848-5611 or visit our web site for the most current product and technical information at [www.itwredhead.com](http://www.itwredhead.com)



# Tapcon<sup>®</sup>

## Concrete and Masonry Anchors

THE ORIGINAL  
**Tapcon**



Blue Climaseal™

410 Stainless Steel

### DESCRIPTION/SUGGESTED SPECIFICATIONS

#### Tapcon Anchors —

SPECIFIED FOR ANCHORAGE INTO CONCRETE, BRICK OR BLOCK

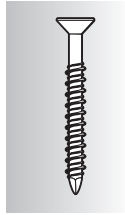

The “original masonry” anchor that cuts its own threads into concrete, brick, or block. Maximum performance is achieved because the Tapcon Anchor, the Condrive Installation Tool, and the carbide-tipped Tapcon Drill Bits are designed to work as a system. It is essential to use the Condrive tool and the correct drill bit to assure consistent anchor performance.

### ADVANTAGES

- Works in all masonry base materials.
- Fast and easy—3 anchors per minute.
- No hole spotting or inserts required.
- Removable.
- Slotted hex and star drive head styles
- Extended corrosion protection—Blue Climaseal™.
- Available in 410 Stainless Steel.
- Pressure treated wood compatible

#### Tapcon Anchors

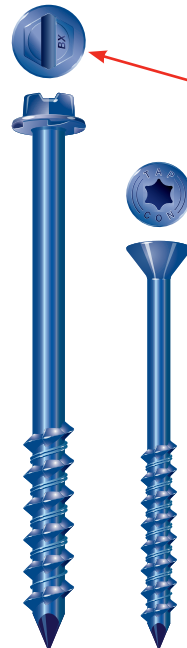

**Blue Climaseal™** provides extended corrosion protection

**Available in 410 Stainless Steel**  
(see photo on left)

**Hex Head** style on Tapcon Anchors is available for majority of fixture anchoring needs  
Patented underhead ribs prevent head snap

**Star Drive Flat Head** style is available when flush seating is necessary in countersink applications

**Advanced Threadform** cuts into concrete and masonry for reduced installation torque and increased pullout performance

**Lengths** of Tapcon Anchors range from 1-1/4" to 3-1/4" in 3/16" and up to 6" in 1/4" diameters

**Nail-Type Point** guides the anchor into the pre-drilled hole. Excellent for wood to concrete applications

Tapcon<sup>®</sup> is a registered trademark of Buildex, a division of Illinois Tool Works, Inc.

### CORROSION RESISTANCE

**Carbon Steel with Blue Climaseal™ Salt Spray Results (ASTM B117)**

720 Hours - 10% or less rust

**410 Stainless Steel with Silver Climashield™ Salt Spray Results (ASTM B117)**

1,600 Hours - 5% or less rust

## APPLICATIONS



The Tapcon Anchor is especially well suited for window and door frames because it performs well in block, is available in a flat head style, and is fast to install.



Many horizontal or "wall" applications are attached with Tapcon Anchor because it is removable and works well in block and brick.



The picture shows the Condrive Installation Kit in action. The kit makes for fast and easy change over from drill bit to driver and controls the driving torque to prevent thread stripping and head snapping in hard base materials.

## FEATURES

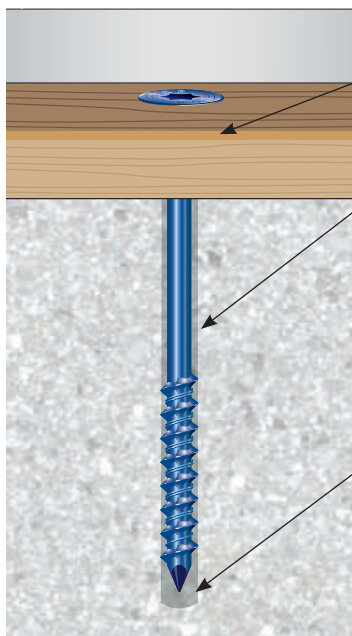

**Fixture Thickness**—determine the fixture thickness to be anchored

**Anchor Embedment**—with a minimum recommended embedment of 1", the correct Tapcon anchor choice can be made. Hole depth must be a minimum 1/4" deeper than the anchor embedment to allow for displaced material

**Hole Diameter**—proper hole diameter is very important to insure consistent performance and maximum pullout strength. 3/16" anchors require 5/32" diameter Tapcon bits, and 1/4" anchors require 3/16" diameter Tapcon bits

## APPROVAL/LISTINGS

### Blue Climaseal™

ICC Evaluation Service, Inc. – ESR-1671  
 ICC Evaluation Service, Inc. – ESR-2202  
 Miami-Dade County NOA 21-0201.06  
 Florida Building Code

### 410 Stainless Steel

Miami-Dade County NOA 21-0201.05  
 Florida Building Code

For the most current approvals/listings visit: [www.itwredhead.com](http://www.itwredhead.com)

## INSTALLATION STEPS

Read installation instructions before using!



### WARNING:

If there are any questions concerning proper installation, applications or appropriate use of this product, please call our Technical Services Department at 1-800-848-5611. Failure to follow these instructions can result in serious personal injury.

- Select proper fastener – diameter / head style / length.**
  - Use selection chart to choose proper length.
- Drill Hole – use selection chart to determine drill bit length and depth of hole.**
  - Use 5/32" diameter Tapcon bit for 3/16" dia. Tapcon Anchor. Use 3/16" diameter Tapcon bit for 1/4" dia. Tapcon Anchor.
  - Drill hole minimum 1/4" deeper than Tapcon Anchor to be embedded.
    - Minimum anchor embedment: 1"
    - Maximum anchor embedment: 1 3/4"
- Drive Anchor using rotary (spin mode) drill.**



### WARNING:

Failure to wear safety glasses with side shields can result in serious personal injury. Always wear ANSI compliant eye protection (ANSI Z87.1-2003).



### WARNING:

Using the wrong size drill bit will affect performance values and may cause failure.

### Drive Styles

3/16" Hex uses 1/4" diameter drive socket  
 1/4" Hex uses 5/16" drive socket



3/16" Star uses T25 drive bit  
 1/4" Star uses T30 drive bit



## SELECTION CHART

### Tapcon® Anchors with Blue Climaseal

Diameter . . . . . 3/16" and 1/4" Thread Form . . . . . Advanced Threadform Technology™  
Point Type . . . . . Nail Finish . . . . . Blue Climaseal™

All boxes of Tapcon anchors come packaged with matching carbide-tipped bit. Tapcon is packaged 100 pieces per box and 500 pieces per master carton except 3205407 and 3203407V2 (400 in master carton).

FIXTURE THICKNESS INCHES	RECOMMENDED TAPCON LENGTH		PART NO. 3/16" HEX HEAD	PART NO. 1/4" HEX HEAD	PART NO. 3/16" FLAT HEAD	PART NO. 1/4" FLAT HEAD	BIT LENGTH		STRAIGHT SHANK BITS FOR 3/16" TAPCON PART NO.	STRAIGHT SHANK BITS FOR 1/4" TAPCON PART NO.
	in.	(mm)					in.	(mm)		
0" – 1/4"	1-1/4	(31.8)	3139407	3153407	3169407V2	3183407V2	3-1/2	(88.9)	–	3098910
1/4" – 3/4"	1-3/4	(44.5)	3141407	3155407	3171407V2	3185407V2	3-1/2	(88.9)	–	3098910
3/4" – 1-1/4"	2-1/4	(57.2)	3143407	3157407	3173407V2	3187407V2	4-1/2	(114.3)	3096910	3099910
1-1/4" – 1-3/4"	2-3/4	(69.9)	3145407	3159407	3175407V2	3189407V2	4-1/2	(114.3)	3096910	3099910
1-3/4" – 2-1/4"	3-1/4	(82.6)	3147407	3161407	3177407V2	3191407V2	5-1/2	(139.7)	3097910	3100910
2-1/4" – 2-3/4"	3-3/4	(95.3)	–	3163407	–	3193407V2	5-1/2	(139.7)	3097910	3100910
2-1/2" – 3"	4	(101.6)	–	3165407	–	3195407V2	5-1/2	(139.7)	3097910	3100910
3-1/2" – 4"	5	(127.0)	–	3167407	–	3197407V2	6-1/2	(165.1)	–	–
4-1/2" – 5"	6	(152.4)	–	3205407	–	3203407V2	7-1/2	(190.5)	–	–

Additional Tapcon bits are available 10 per tube.

## SELECTION CHART

### Tapcon® 410 SS Anchor

Diameter . . . . . 3/16" and 1/4" Thread Form . . . . . Original Notched Hi-Lo™  
Point Type . . . . . Nail Finish . . . . . 410 Stainless Steel with Silver Climashield™

All boxes of Tapcon anchors come packaged with matching carbide-tipped bit. Tapcon is packaged 100 pieces per box and 500 pieces per master carton.

FIXTURE THICKNESS INCHES	RECOMMENDED TAPCON LENGTH		PART NO. 1/4" HEX HEAD	PART NO. 3/16" FLAT HEAD	PART NO. 1/4" FLAT HEAD	BIT LENGTH		STRAIGHT SHANK BITS FOR 3/16" TAPCON PART NO.	STRAIGHT SHANK BITS FOR 1/4" TAPCON PART NO.
	in.	(mm)				in.	(mm)		
0" – 1/4"	1-1/4	(31.8)	3367907	–	3373907	3-1/2	(88.9)	–	3098910
1/4" – 3/4"	1-3/4	(44.5)	3368907	3418907	3374907	3-1/2	(88.9)	–	3098910
3/4" – 1-1/4"	2-1/4	(57.2)	3369907	3419907	3375907	4-1/2	(114.3)	3096910	3099910
1-1/4" – 1-3/4"	2-3/4	(69.9)	3370907	3420907	3376907	4-1/2	(114.3)	3096910	3099910
1-3/4" – 2-1/4"	3-1/4	(82.6)	3371907	–	3377907	5-1/2	(139.7)	3097910	3100910
2-1/4" – 2-3/4"	3-3/4	(95.3)	3372907	–	3378907	5-1/2	(139.7)	3097910	3100910
2-1/2" – 3"	4	(101.6)	–	–	–	5-1/2	(139.7)	–	3100910
3-1/2" – 4"	5	(127.0)	3460907	–	–	6-1/2	(165.1)	–	–
4-1/2" – 5"	6	(152.4)	–	–	–	7-1/2	(190.5)	–	–

### Tapcon® SDS Bits

PART NUMBER	DESCRIPTION
3311910	7" (SDS Rotohammer Bits for use with 3/16" Tapcon)
7901060	5" (SDS Rotohammer Bits for use with 1/4" Tapcon)

All SDS bits are sold individually.

## PERFORMANCE TABLE

### Tapcon® Anchors

### Ultimate Tension and Shear Values (lbs/kN) in Solid Concrete

ANCHOR DIA.	MIN. DEPTH OF EMBEDMENT		f'c = 2000 PSI (13.8 MPa)				f'c = 3000 PSI (20.7 MPa)				f'c = 4000 PSI (27.6 MPa)				f'c = 5000 PSI (34.5 MPa)				
			TENSION		SHEAR		TENSION		SHEAR		TENSION		SHEAR		TENSION		SHEAR		
			lbs.	(kN)	lbs.	(kN)	lbs.	(kN)	lbs.	(kN)	lbs.	(kN)	lbs.	(kN)	lbs.	(kN)	lbs.	(kN)	
3/16	(4.8)	1	(25.4)	600	(2.7)	720	(3.2)	625	(2.8)	720	(3.2)	650	(2.9)	720	(3.2)	800	(3.6)	860	(3.8)
		1-1/4	(31.8)	845	(3.7)	720	(3.2)	858	(3.8)	720	(3.2)	870	(3.9)	720	(3.2)	1,010	(4.5)	860	(3.8)
		1-1/2	(38.1)	1,090	(4.8)	860	(3.8)	1,090	(4.8)	860	(3.8)	1,090	(4.8)	860	(3.8)	1,220	(5.4)	860	(3.8)
		1-3/4	(44.5)	1,450	(6.5)	870	(3.9)	1,455	(6.5)	870	(3.9)	1,460	(6.5)	990	(4.4)	1,730	(7.7)	990	(4.4)
1/4	(6.4)	1	(25.4)	750	(3.3)	900	(4.0)	775	(3.4)	900	(4.0)	800	(3.6)	1,360	(6.1)	950	(4.2)	1,440	(6.4)
		1-1/4	(31.8)	1,050	(4.7)	900	(4.0)	1,160	(5.2)	900	(4.0)	1,270	(5.6)	1,360	(6.1)	1,515	(6.7)	1,440	(6.4)
		1-1/2	(38.1)	1,380	(6.1)	1,200	(5.3)	1,600	(7.2)	1,200	(5.3)	1,820	(8.1)	1,380	(6.1)	2,170	(9.7)	1,670	(7.4)
		1-3/4	(44.5)	2,020	(9.0)	1,670	(7.4)	2,200	(9.8)	1,670	(7.4)	2,380	(10.6)	1,670	(7.4)	2,770	(12.3)	1,670	(7.4)

Safe working loads for single installation under static loading should not exceed 25% of the ultimate load capacity.



## PERFORMANCE TABLE

### Tapcon Anchors

### Ultimate Tension and Shear Values (lbs/kN) in Hollow Block

ANCHOR DIAMETER		ANCHOR EMBEDMENT		LIGHTWEIGHT BLOCK				MEDIUM WEIGHT BLOCK			
in.	(mm)	in.	(mm)	TENSION		SHEAR		TENSION		SHEAR	
				lbs.	(kN)	lbs.	(kN)	lbs.	(kN)	lbs.	(kN)
3/16	(4.8)	1	(25.4)	220	(1.0)	400	(1.8)	340	(1.5)	730	(3.2)
1/4	(6.4)	1	(25.4)	250	(1.1)	620	(2.8)	500	(2.2)	1,000	(4.4)

Safe working loads for single installation under static loading should not exceed 25% of the ultimate load capacity.

**NOTE:** 3/16" Tapcon requires 5/32" bit, 1/4" Tapcon requires 3/16" bit.

## PERFORMANCE TABLE

### Tapcon® Anchors

### Allowable Edge and Spacing Distances

PARAMETER	ANCHOR DIAMETER		NORMAL WEIGHT CONCRETE			CONCRETE MASONRY UNITS (CMU)		
	in.	(mm)	FULL CAPACITY (Critical Distance Inches)	REDUCED CAPACITY (Minimal Distance Inches)	LOAD REDUCTION FACTOR	FULL CAPACITY (Critical Distance Inches)	REDUCED CAPACITY (Minimal Distance Inches)	LOAD REDUCTION FACTOR
Spacing Between Anchors - Tension	3/16	(4.8)	3	1-1/2	0.73	3	1-1/2	1.00
	1/4	(6.4)	4	2	0.66	4	2	0.84
Spacing Between Anchors - Shear	3/16	(4.8)	3	1-1/2	0.83	3	1-1/2	1.00
	1/4	(6.4)	4	2	0.82	4	2	0.81
Edge Distance - Tension	3/16	(4.8)	1-7/8	1	0.83	4	2	0.91
	1/4	(6.4)	2-1/2	1-1/4	0.82	4	2	0.88
Edge Distance - Shear	3/16	(4.8)	2-1/4	1-1/8	0.70	4	2	0.93
	1/4	(6.4)	3	1-1/2	0.59	4	2	0.80

For SI: 1 inch = 25.4 mm

## Tapcon® Condrive Tool Kit

### DESCRIPTION/SUGGESTED SPECIFICATIONS

### Condrive Installation Tool— SPECIFIED FOR ANCHORAGE INTO CONCRETE, BRICK OR BLOCK

The key to Tapcon's fast and easy installation is the multi-purpose Condrive Installation Tool. The drive sleeve, along with the hex head and phillips sockets provide the installer with the flexibility necessary for the complete variety of Tapcon applications (tool does not include drill bit).

Condrive® Tool - A multi-purpose tool designed for installation of Tapcon hex head and Phillips flat head anchors up to 3-3/4" long. If driving hex head Tapcon, driver will automatically disengage. The Condrive Tool has a reusable plastic case.

Condrive Tools are designed to specifically install Tapcon Anchors and to fit standard hammer drills.



Part No. 3103910  
(Does not include drill bit)

### APPLICATIONS



The picture shows the Condrive Installation Kit in action. The kit makes for fast and easy change over from drill bit to driver and controls the driving torque to prevent thread stripping and head snapping in hard base materials.

### ADVANTAGES

- Fast change from drilling to driving
- Eliminates need to change out chucks and bits
- Eliminates need for two tools
- Special nut driver is recessed for torque control to reduce head breakage

### Condrive Tool Kit Parts (sold only as a kit)

A	Drill Adapter
B	Sleeve
C	3/16" Socket
D	1/4" Socket
E	Phillips/Star Socket
F	Hex Key
G	T25 Star Drive Bit
H	T30 Star Drive Bit
I	#2 Phillips Drive Bit
J	#3 Phillips Drive Bit



Call our toll free number 800-848-5611 or visit our web site for the most current product and technical information at [www.itwredhead.com](http://www.itwredhead.com)



# Tapcon® Maxi-Set Anchors



White UltraShield    UltraShield

## DESCRIPTION/SUGGESTED SPECIFICATIONS

FOR TAPCON APPLICATIONS THAT REQUIRE MORE ANCHOR BEARING SURFACE.

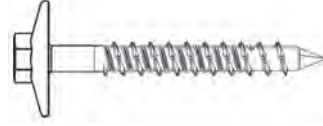

## ADVANTAGES

- Same reliable performance and speed of installation as regular Tapcon.
- UltraShield™ and White UltraShield™ long-life finish deliver excellent corrosion resistance.
- Large 5/8" diameter flange provides more bearing surface and increases pullover resistance.
- High 5/16" hex head adds driving stability.

## CORROSION RESISTANCE

Salt Spray Test (ASTM B117)	UltraShield	White UltraShield
	1100 Hrs 10% or less red rust	1500 Hrs 10% or less red rust

## APPROVAL/LISTINGS

ICC Evaluation Service, Inc. – #ESR-1671  
Miami-Dade County – NOA 21-0201.06

For the most current approvals/listings  
visit: [www.itwredhead.com](http://www.itwredhead.com)

## INSTALLATION STEPS

Read installation instructions before using!



**WARNING:**

If there are any questions concerning proper installation, applications or appropriate use of this product, please call our Technical Services Department at 1-800-848-5611. Failure to follow these instructions can result in serious personal injury.

- Select proper fastener – diameter / head style / length.
  - Use selection chart to choose proper length.
- Drill Hole – use selection chart to determine drill bit length and depth of hole.
  - Use 3/16" diameter Tapcon bit.
  - Drill hole minimum 1/4" deeper than Tapcon Anchor to be embedded.
    - Minimum anchor embedment: 1"
    - Maximum anchor embedment: 1 3/4"
- Drive anchor using 5/16" socket.



**WARNING:**

Failure to wear safety glasses with side shields can result in serious personal injury. Always wear ANSI compliant eye protection (ANSI Z87.1-2003).



**WARNING:**

Using the wrong size drill bit will affect performance values and may cause failure.

## APPLICATIONS



Shutters - protective and decorative

Screened porch and pool enclosures.

Various sheet metal flashings.



Decorative wrought iron.

Wood nailers and plywood attachment.

## SELECTION CHART

### Tapcon® Maxi-Set Anchors

Diameter . . . . . 1/4"      Thread Form . . . . Advanced Threadform Technology™  
 Point Type . . . . Nail      Finish . . . . . UltraShield™ or \*White UltraShield™  
 Head Style . . . . 5/16" cross flats hex with 5/8" diameter flange.

RECOMMENDED TAPCON LENGTH		PART NO. 1/4" HEX HEAD	FINISH	BIT LENGTH		STRAIGHT SHANK BITS FOR 1/4" TAPCON PART NO.
in.	(mm)			in.	(mm)	
1-3/4	(44.5)	3294000	Ultra Shield	3-1/2	(88.9)	3098910
1-3/4	(44.5)	3383100	White Ultra Shield	3-1/2	(88.9)	3098910
2-1/4	(57.2)	3384100	White Ultra Shield	4-1/2	(114.3)	3099910
3-1/4	(82.6)	3409100	White Ultra Shield	5-1/2	(139.7)	3100910

Maxi-Sets are packed 1,000 pieces per master carton except 3409100 is packed 750 pieces.

## SELECTION CHART

### Tapcon SDS Bits

PART NO.	DESCRIPTION
3311910	7" (SDS Rotohammer Bits for use with 3/16" Tapcon)
7901060	5" (SDS Rotohammer Bits for use with 1/4" Tapcon)

## PERFORMANCE TABLE

### Tapcon® Maxi-Set Anchors

### Ultimate Tension and Shear Values (lbs/kN) in Solid Concrete

ANCHOR DIAMETER in. (mm)	MIN. DEPTH OF EMBEDMENT in. (mm)	f'c = 2000 PSI (13.8 MPa)				f'c = 3000 PSI (20.7 MPa)				f'c = 4000 PSI (27.6 MPa)				f'c = 5000 PSI (34.5 MPa)				
		TENSION		SHEAR		TENSION		SHEAR		TENSION		SHEAR		TENSION		SHEAR		
		lbs.	(kN)	lbs.	(kN)	lbs.	(kN)	lbs.	(kN)	lbs.	(kN)	lbs.	(kN)	lbs.	(kN)	lbs.	(kN)	
1/4	1	(25.4)	750	(3.3)	900	(4.0)	775	(3.4)	900	(4.0)	800	(3.6)	1,360	(6.1)	950	(4.2)	1,440	(6.4)
	1-1/4	(31.8)	1,050	(4.7)	900	(4.0)	1,160	(5.2)	900	(4.0)	1,270	(5.6)	1,360	(6.1)	1,515	(6.7)	1,440	(6.4)
	1-1/2	(38.1)	1,380	(6.1)	1,200	(5.3)	1,600	(7.2)	1,200	(5.3)	1,820	(8.1)	1,380	(6.1)	2,170	(9.7)	1,670	(7.4)
	1-3/4	(44.5)	2,020	(9.0)	1,670	(7.4)	2,200	(9.8)	1,670	(7.4)	2,380	(10.6)	1,670	(7.4)	2,770	(12.3)	1,670	(7.4)

Allowable working loads for the single installation under static loading should not exceed 25% capacity of the Ultimate Load. To calculate the Allowable Load, divide the Ultimate Load by 4.

## PERFORMANCE TABLE

### Tapcon® Maxi-Set Anchors

### Ultimate Tension and Shear Values (lbs/kN) in Hollow Block

ANCHOR DIAMETER in. (mm)		ANCHOR EMBEDMENT in. (mm)		LIGHTWEIGHT BLOCK				MEDIUM WEIGHT BLOCK			
				TENSION		SHEAR		TENSION		SHEAR	
lbs.	(kN)	lbs.	(kN)	lbs.	(kN)	lbs.	(kN)	lbs.	(kN)	lbs.	(kN)
1/4	(6.4)	1	(25.4)	250	(1.1)	620	(2.8)	500	(2.2)	1,000	(4.4)

Allowable working loads for the single installation under static loading should not exceed 25% capacity of the Ultimate Load. To calculate the Allowable Load, divide the Ultimate Load by 4.

NOTE: 3/16" Tapcon requires 5/32" bit, 1/4" Tapcon requires 3/16" bit.

## PERFORMANCE TABLE

### Tapcon® Maxi-Set Anchors

### Allowable Edge and Spacing Distances

PARAMETER	ANCHOR DIAMETER		NORMAL WEIGHT CONCRETE			CONCRETE MASONRY UNITS (CMU)		
	in.	(mm)	FULL CAPACITY (Critical Distance Inches)	REDUCED CAPACITY (Minimal Distance Inches)	LOAD REDUCTION FACTOR	FULL CAPACITY (Critical Distance Inches)	REDUCED CAPACITY (Minimal Distance Inches)	LOAD REDUCTION FACTOR
Spacing Between Anchors - Tension	1/4	(6.4)	4	2	0.66	4	2	0.84
Spacing Between Anchors - Shear	1/4	(6.4)	4	2	0.82	4	2	0.81
Edge Distance - Tension	1/4	(6.4)	2-1/2	1-1/4	0.82	4	2	0.88
Edge Distance - Shear	1/4	(6.4)	3	1-1/2	0.59	4	2	0.80

For SI: 1 inch = 25.4 mm



Call our toll free number 800-848-5611 or visit our web site for the most current product and technical information at [www.itwredhead.com](http://www.itwredhead.com)



# Tapcon® SCOTS Anchors



## APPLICATIONS



Shutters - protective and decorative



Screened porch and pool enclosures  
Aluminum fixtures  
Railings

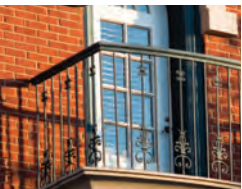

Metal roofing  
Flexible flashings

## DESCRIPTION/SUGGESTED SPECIFICATIONS

PREMIUM CONCRETE ANCHOR THAT COMBINES THE CORROSION PROTECTION OF STAINLESS STEEL WITH THE PERFORMANCE OF TAPCON ANCHORS.



## ADVANTAGES

- 300 Series Stainless Steel head and Carbon Steel body.
- Integral washer design provides more bearing surface.
- Rubber EPDM sealing washer "locks-out" moisture from building interior.
- Head paint available in white or bronze (extra charge).
- Delivers the same holding performance as Tapcon anchors with Blue Climaseal™.
- Reduces replacement of "weathered" fasteners.

## CORROSION RESISTANCE

300 Series Stainless Steel SCOTS Cap  
Salt Spray Results (ASTM B117)

Never Rusts

Carbon Steel with Ultrashield™  
Salt Spray Results (ASTM B117)

1,100 Hours - 10% or less rust

## APPROVAL/LISTINGS

ICC Evaluation Service, Inc. – ESR-1671

Miami-Dade County – NOA 21-0201.06

For the most current approvals/listings  
visit: [www.itwredhead.com](http://www.itwredhead.com)

## INSTALLATION STEPS

Read installation instructions before using!



**WARNING:**

If there are any questions concerning proper installation, applications or appropriate use of this product, please call our Technical Services Department at 1-800-848-5611. Failure to follow these instructions can result in serious personal injury.

1. **Select proper fastener – diameter / head style / length.**
  - a) Use selection chart to choose proper length.
2. **Drill Hole – use selection chart to determine drill bit length and depth of hole.**
  - a) Use 3/16" diameter Tapcon bit.
  - b) **Drill hole minimum 1/4" deeper than Tapcon Anchor to be embedded.**  
Minimum anchor embedment: 1"  
Maximum anchor embedment: 1 3/4"
3. **Drive anchor using 5/16" socket.**



**WARNING:**

Failure to wear safety glasses with side shields can result in serious personal injury. Always wear ANSI compliant eye protection (ANSI Z87.1-2003).



**WARNING:**

Using the wrong size drill bit will affect performance values and may cause failure.

## SELECTION CHART

**Tapcon®  
SCOTS Anchors**

Diameter . . . . . 1/4" Thread Form . . . . . Advanced Threadform Technology™  
Point Type . . . . . Nail Finish . . . . . Silver Climaseal™  
Head Style . . . . . 5/16" HWH (300 Series Stainless)

RECOMMENDED TAPCON LENGTH		PART NO. 1/4" HEX HEAD	BIT LENGTH		PART NO. STRAIGHT SHANK BITS FOR 1/4" TAPCON
in.	(mm)		in.	(mm)	
1-3/4	(44.5)	3358407	3-1/2	(88.9)	3098910

SCOTS are packed 1,000 pieces per master, 100 pieces per inner.

## SELECTION CHART

**Tapcon®  
SDS Bits**

PART NO.	DESCRIPTION
3311910	7" (SDS Rotohammer Bits for use with 3/16" Tapcon)
7901060	5" (SDS Rotohammer Bits for use with 1/4" Tapcon)

## PERFORMANCE TABLE

**Tapcon®  
SCOTS Anchors**

**Ultimate Tension and Shear Values (lbs/kN)  
in Solid Concrete**

ANCHOR DIAMETER in. (mm)	MIN. DEPTH OF EMBEDMENT in. (mm)	f <sub>c</sub> = 2000 PSI (13.8 MPa)				f <sub>c</sub> = 3000 PSI (20.7 MPa)				f <sub>c</sub> = 4000 PSI (27.6 MPa)				f <sub>c</sub> = 5000 PSI (34.5 MPa)				
		TENSION		SHEAR		TENSION		SHEAR		TENSION		SHEAR		TENSION		SHEAR		
		lbs.	(kN)	lbs.	(kN)	lbs.	(kN)	lbs.	(kN)	lbs.	(kN)	lbs.	(kN)	lbs.	(kN)	lbs.	(kN)	
1/4	1	(25.4)	750	(3.3)	900	(4.0)	775	(3.4)	900	(4.0)	800	(3.6)	1,360	(6.1)	950	(4.2)	1,440	(6.4)
	1-1/4	(31.8)	1,050	(4.7)	900	(4.0)	1,160	(5.2)	900	(4.0)	1,270	(5.6)	1,360	(6.1)	1,515	(6.7)	1,440	(6.4)
	1-1/2	(38.1)	1,380	(6.1)	1,200	(5.3)	1,600	(7.2)	1,200	(5.3)	1,820	(8.1)	1,380	(6.1)	2,170	(9.7)	1,670	(7.4)
	1-3/4	(44.5)	2,020	(9.0)	1,670	(7.4)	2,200	(9.8)	1,670	(7.4)	2,380	(10.6)	1,670	(7.4)	2,770	(12.3)	1,670	(7.4)

Allowable working loads for the single installation under static loading should not exceed 25% capacity of the Ultimate Load. To calculate the Allowable Load, divide the Ultimate Load by 4.

## PERFORMANCE TABLE

**Tapcon®  
SCOTS Anchors**

**Ultimate Tension and Shear Values (lbs/kN)  
in Hollow Concrete Masonry Units**

ANCHOR DIAMETER in. (mm)		ANCHOR EMBEDMENT in. (mm)		LIGHTWEIGHT BLOCK				MEDIUM WEIGHT BLOCK			
				TENSION		SHEAR		TENSION		SHEAR	
				lbs.	(kN)	lbs.	(kN)	lbs.	(kN)	lbs.	(kN)
1/4	(6.4)	1	(25.4)	250	(1.1)	620	(2.8)	500	(2.2)	1,000	(4.4)

Allowable working loads for the single installation under static loading should not exceed 25% capacity of the Ultimate Load. To calculate the Allowable Load, divide the Ultimate Load by 4.

NOTE: 3/16" Tapcon requires 5/32" bit, 1/4" Tapcon requires 3/16" bit.

## PERFORMANCE TABLE

**Tapcon®  
SCOTS Anchors**

**Allowable Edge  
and Spacing Distances**

PARAMETER	ANCHOR DIAMETER		NORMAL WEIGHT CONCRETE			CONCRETE MASONRY UNITS (CMU)		
	in.	(mm)	FULL CAPACITY (Critical Distance Inches)	REDUCED CAPACITY (Minimal Distance Inches)	LOAD REDUCTION FACTOR	FULL CAPACITY (Critical Distance Inches)	REDUCED CAPACITY (Minimal Distance Inches)	LOAD REDUCTION FACTOR
Spacing Between Anchors - Tension	1/4	(6.4)	4	2	0.66	4	2	0.84
Spacing Between Anchors - Shear	1/4	(6.4)	4	2	0.82	4	2	0.81
Edge Distance - Tension	1/4	(6.4)	2-1/2	1-1/4	0.82	4	2	0.88
Edge Distance -Shear	1/4	(6.4)	3	1-1/2	0.59	4	2	0.80

For SI: 1 inch = 25.4 mm



Call our toll free number 800-848-5611 or visit our web site for the most current product and technical information at [www.itwredhead.com](http://www.itwredhead.com)





# Tapcon® XL Anchors



UltraShield

## APPLICATIONS



Shutters - protective and decorative



Screened porch and pool enclosures.

Railings

Mounted electrical equipment



Sill plates

## DESCRIPTION/SUGGESTED SPECIFICATIONS

EXTRA LARGE TAPCON FOR EXTRA LARGE CHALLENGES!

## ADVANTAGES

- Internal TORX® T-40 drive assures easy installation.
  - High button head resists cam-out during installation.
  - Corrosion protection of UltraShield™ to combat aggressive environments.
  - Available in silver.
  - Delivers over 3,000 lbs. holding power in concrete.
  - Alternative to sleeve anchors.
- Use 1/4" Tapcon Drill Bit**

## CORROSION RESISTANCE

Salt Spray Test (ASTM B117)    UltraShield  
1100 Hrs 10% or less rust

## APPROVAL

Miami-Dade County – NOA 21-0201.05

## INSTALLATION STEPS

Read installation instructions before using!



**WARNING:**

If there are any questions concerning proper installation, applications or appropriate use of this product, please call our Technical Services Department at 1-800-848-5611. Failure to follow these instructions can result in serious personal injury.

### 1. Drill Hole minimum ¼" deeper than Tapcon Anchor to be embedded.

Minimum anchor embedment: 1"  
Maximum anchor embedment: 1¾"

### 2. Drive anchor using T-40 Torx® Drive



**WARNING:**

Failure to wear safety glasses with side shields can result in serious personal injury. Always wear ANSI compliant eye protection (ANSI Z87.1-2003).



**WARNING:**

Using the wrong size drill bit will affect performance values and may cause failure.

## SELECTION CHART

**Tapcon® XL Anchors**  
 Diameter . . . . . 5/16"    Thread Form . . . . . Reverse Hi-Lo®  
 Point Type . . . . . Nail    Finish . . . . . UltraShield™  
 Head Style . . . . . High button with TORX T-40 Drive

RECOMMENDED TAPCON LENGTH		PART NO.	FINISH
in.	(mm)		
2-1/4	(57.2)	3395902	Ultra Shield

XLs are packed 100 pieces per master carton.

## PERFORMANCE TABLE

**Tapcon® XL Anchors**  
**Ultimate Tension and Shear Values (lbs/kN)  
 in Solid Concrete**

ANCHOR DIAMETER in. (mm)		MIN. DEPTH OF EMBEDMENT in. (mm)		EDGE DISTANCE in. (mm)		f'c = 3000 PSI (20.7 MPa)			
						TENSION		SHEAR	
						lbs.	(kN)	lbs.	(kN)
5/16	(7.9)	1-1/4	(31.8)	1-9/16	(39.7)	1,050	(4.7)	1,330	(5.9)
				2-3/16	(55.6)	1,205	(5.4)	1,725	(7.7)
		1-3/4	(44.5)	1-9/16	(39.7)	2,020	(9.0)	1,530	(6.8)
				2-3/16	(55.6)	2,250	(10.0)	2,505	(11.1)
		2-1/4	(57.2)	1-9/16	(39.7)	2,850	(12.7)	1,955	(8.9)
				2-3/16	(55.6)	3,120	(13.9)	3,250	(14.4)

Allowable working loads for the single installation under static loading should not exceed 25% capacity of the Ultimate Load. To calculate the Allowable Load, divide the Ultimate load by 4  
 Pilot hole diameter – Use 1/4" ANSI spec carbide tipped drill bit. Drill 1/4" longer than necessary embedment.  
 Recommended center to center distance of 3-3/4" is required for 100% efficiency and 1-7/8" for 50% efficiency.

## PERFORMANCE TABLE

**Tapcon® XL Anchors**  
**Ultimate Tension and Shear Values  
 in Concrete Masonry Units**

ANCHOR DIAMETER in. (mm)		MINIMUM DEPTH OF EMBEDMENT in. (mm)		EDGE DISTANCE in.	HOLLOW BLOCK <sup>1</sup>				GROUT-FILLED BLOCK <sup>2</sup>			
					TENSION		SHEAR		TENSION		SHEAR	
					lbs.	(kN)	lbs.	(kN)	lbs.	(kN)	lbs.	(kN)
5/16	(7.9)	1-1/4	(31.8)	4	1,045	(4.6)	2,280	(10.1)	1,045	(4.6)	2,280	(10.1)
		1-3/4	(44.5)	4	NOT RECOMMENDED		NOT RECOMMENDED		1,950	(8.7)	2,825	(12.6)
		2-1/4	(57.2)	4	NOT RECOMMENDED		NOT RECOMMENDED		3,770	(16.8)	3,140	(14.0)

Allowable working loads for the single installation under static loading should not exceed 25% capacity of the Ultimate Load. To calculate the Allowable Load, divide the Ultimate load by 4  
 1. CMU = 1,600 PSI minimum compressive strength.  
 2. CMU = 1,600 PSI minimum compressive strength with 2,000 PSI grout.  
 Embedment is through 1-1/4" face shell of hollow block.



## Conversion Table (soft)

6.35 mm = 1/4"	50 mm = 2"
9.5 mm = 3/8"	98 mm = 3-7/8"
10 mm = 3/8"	100 mm = 4"
12 mm = 1/2"	130 mm = 5-1/8"
16 mm = 5/8"	153 mm = 6"
20 mm = 3/4"	156 mm = 6-1/8"
22 mm = 7/8"	178 mm = 7"
24 mm = 1"	183 mm = 7-1/4"
25 mm = 1"	190 mm = 7-1/2"
30 mm = 1-3/16"	200 mm = 7-7/8"
35 mm = 1-3/8"	213 mm = 8-3/8"
40 mm = 1-1/2"	250 mm = 9-7/8"

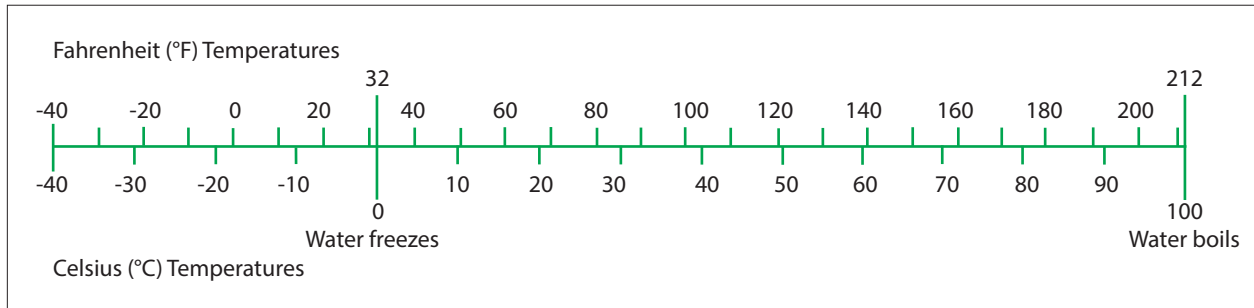



# **RED HEAD<sup>®</sup>**

***CONCRETE ANCHORING SPECIALISTS***

## **NATIONAL HEADQUARTERS**

ITW COMMERCIAL CONSTRUCTION,  
NORTH AMERICA  
155 HARLEM AVE,  
GLENVIEW, IL 60025  
PHONE: 800-848-5611  
FAX: 630-893-1270

## **TECHNICAL SUPPORT**

PHONE: 800-848-5611  
HOURS: 8:30 A.M. - 5:00 P.M. (CST, M-F)  
EMAIL: [TECHSUPPORT@ITWCCNA.COM](mailto:TECHSUPPORT@ITWCCNA.COM)

## **WILL CALL/DISTRIBUTION**

2501 GALVIN DR  
ELGIN, IL 60123  
PHONE: 800-848-5611

## **CUSTOMER SERVICE**

PHONE: 800-848-5611  
HOURS: 7:30 A.M. - 5:00 P.M. (CST, M-F)  
EMAIL: [ORDERS@ITWCCNA.COM](mailto:ORDERS@ITWCCNA.COM)

[www.itwredhead.com](http://www.itwredhead.com)